

5-Phase Stepping Motor and Driver Package CRK Series

● Connection Information
 Technical reference → Page G-1
 Safety standards → Page H-2

This series is a motor and driver package product that combines a high-performance, 5-phase stepping motor with a compact and low-vibration microstep driver. The lineup consists of a Built-In Controller Package or a Pulse Input Package.



● For detailed product safety standard information including standards, file number and certification body, please visit www.orientalmotor.eu.
 *Pulse Input Packages only.



Features

● Low Vibration and Noise Reduction

◇ Lower Vibration and Noise Achieved by Microstepping

The basic step angle of the motor can be divided into a maximum of 250 microstep angles without using any mechanical element such as a reduction gear. As a result, vibration and noise are further reduced.

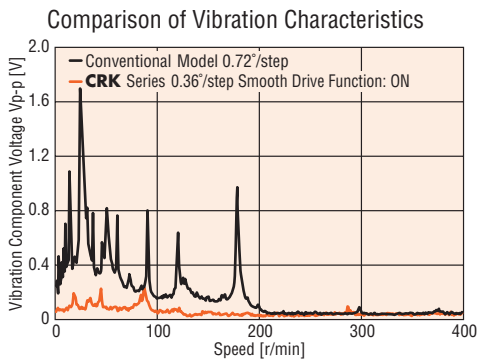

◇ Smooth Drive Function for Enhanced Ease of Use

The Smooth Drive Function automatically controls motion via microstepping at the same travel amount and speed used in the full-step mode.

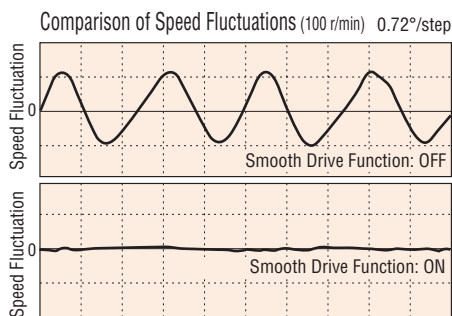

● Wide Variety of Motors

This series offers models ranging from the high-resolution type, high-torque type and standard type, as well as various geared types.

You can find a product meeting your specific torque, resolution or other needs from a wide range of specifications.

◇ High-Resolution Motor

● Improved Stopping Accuracy

The positioning accuracy of a stepping motor is affected by the friction of the load.

The High-Resolution type achieves high accuracy and reliability based on Oriental Motor's latest precision machining technology. The motor resolution is increased to double the level of a standard model to reduce the displacement angle against load torque, thereby achieve high positioning accuracy. Vibration is also reduced.

Standard type: 50 teeth
 Resolution: 500 steps per rotation
 = 0.72°/step

High-Resolution type: 100 teeth
 Resolution: 1000 steps per rotation
 = 0.36°/step



Resolution is increased!

Comparison of Angle – Torque Characteristics

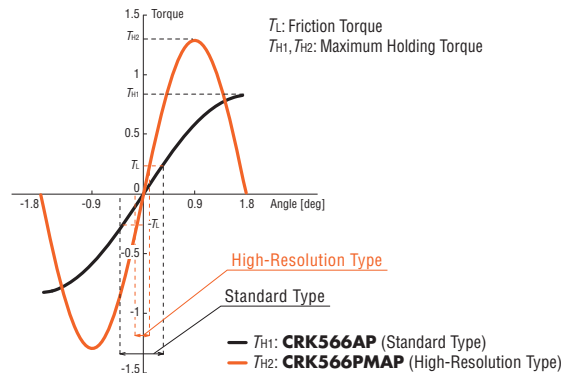

• Stop Position Accuracy of 2 Arc Minutes (No load)

The High-Resolution type is designed with a stop position accuracy of ± 2 arc minutes ($\pm 0.034^\circ$) [standard type: ± 3 arc minutes ($\pm 0.05^\circ$)]. The reduced error helps improve the positioning accuracy of your equipment.

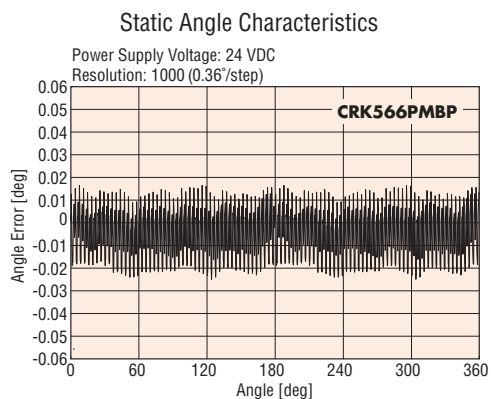

◇ High-Torque Motors

The high-resolution type and high-torque type adopt a newly designed high-torque motor that widens the range of applications.

- The smaller motor allows for compact equipment design.
- The motor current is reduced to suppress heat generation.

Example: Avoidance of temperature rise in precision equipment or machinery

Comparison of Speed – Torque Characteristics

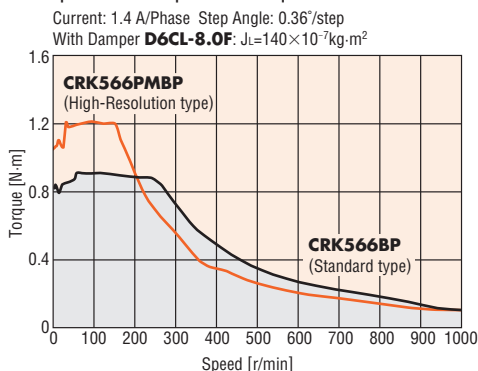

◇ High-Speed Specification Motors

The high-speed specification type has high torque up to the high-speed rotation range, so positioning operations using the high-speed rotation range are possible. As a result, the positioning operation time can be reduced.

The torque of high-speed specification motors at 1000 r/min with the **CRK524** type is about 2 times that in standard motors.

Comparison of Speed – Torque Characteristics

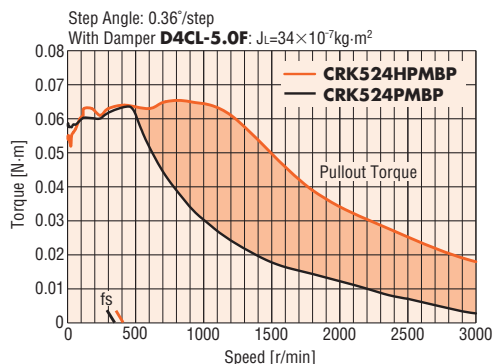

◇ Encoder Type Motors

Built-in controller types use encoder type motors, making it possible to detect positional errors. This contributes to even better equipment reliability.

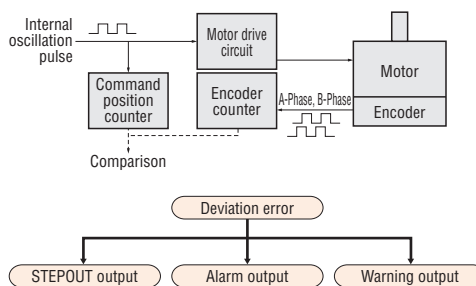

• STEPOUT Output Function

If the deviation between the driver command position and encoder counter value reaches the setting value (deviation error), a STEPOUT signal is output. Positional errors due to rapid changes in load, etc. can be detected.

• Alarm Output Function*

When a deviation error occurs, an overflow alarm is generated and the motor is stopped.

• Warning Output Function*

When a deviation error occurs, an overflow warning is generated. The motor continues to operate.

*Whether an alarm or a warning is output when a deviation error has occurred is set with parameters.

• Application

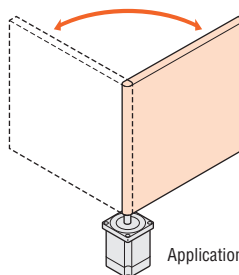

The door not being able to move to its normal position due to an obstruction, etc. can be detected.

Applications: Opening and closing of door

◇ Motor with Electromagnetic Brake

This type is combined with a power off activated type electromagnetic brake. When the power is accidentally cut off due to a power outage or another unexpected event, the electromagnetic brake holds the load in position to prevent it from dropping or moving.

Selectable Drivers by System

Built-In Controller

● I/O Control

A built-in pulse generation function allows the motor to be driven via a directly connected programmable controller. Since no separate pulse generator is required, drivers of this type save space and simplify the system.

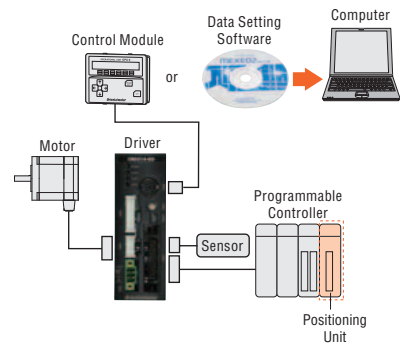

● Modbus (RTU) Control

Operating data, parameter settings or operation commands can be input via RS-485 communication. A maximum of 31 drivers can be connected to one serial unit. There is also a function for simultaneously starting multiple axes. The protocol is compatible with Modbus (RTU) and can be easily connected via PLC, etc.

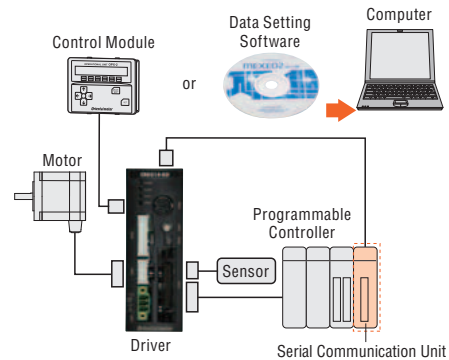

Pulse Input

● Pulse Control

The motor can be controlled using a pulse generator provided by the customer. Operating data registered in the pulse generator is selected from the programmable controller to operate the motor.

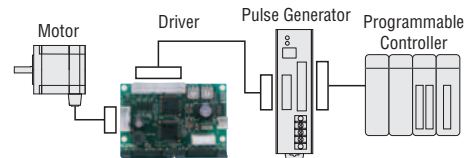

◇ Compact Drivers that Conform to DIN Rails (Only for Built-In Controller Package)

● Case Type, Compact DC Power Supply Input Drivers

A compact driver with dimensions of width 35 mm×height 100 mm×depth 70 mm. This contributes to space saving for the control box and equipment.



● DIN Rail Installable

A DIN rail can be installed directly. This eliminates the need for installation screws.

● Installation is only possible with a DIN rail.



Features of the Built-In Controller Package

Compact Driver with Built-In Controller Function

Space Saving and Simple Wiring

The **CRK** Series with built-in controller is a compact, space saving stepping motor and driver package with a powerful, feature-rich controller built-in.

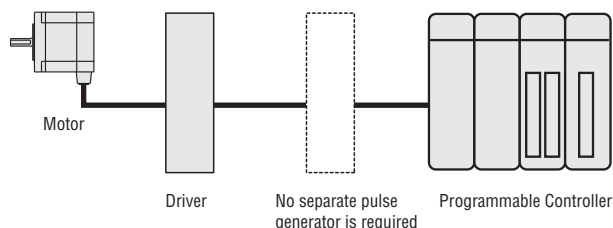

Maximum 63 Points of Operating Data

Up to 63 points of operating data can be set in the driver. Setting of incremental (relative-distance specification) mode and absolute (absolute-position specification) mode for each data is possible.

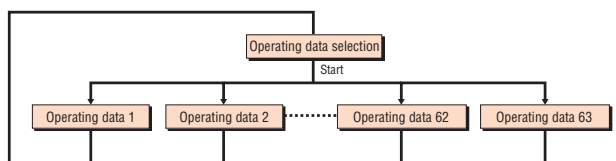

Operating data is set with either the accessory (sold separately) control module **OPX-2A**, the data setting software **MEXE02**, or RS-485 communication.

Three Operating Functions

Positioning Operation

The motor's operating speed and traveling amount are set in the operating data, and operations are performed in accordance with the selected operating data.

Linked Operation

If the linked data is set to "linked," continuous positioning with the following data number is possible with the first START signal.

[Linked operation]

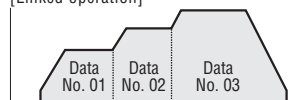

If data No. 01 is selected and START input, linked driving from data No. 01 to No. 03 is performed without the motor stopping.

[Linked operation 2]

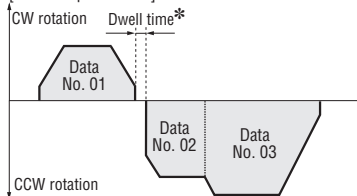

If data No. 01 is selected and START input, the data No. 01 operation is executed. After that, it is stopped for only the set dwell time* and then the operations from data No. 02 to No. 03 are executed. Operating data with a different rotation direction can also be linked.

*Dwell time is the wait time until the next positioning operation starts.

Sequential Operation

If the operating data is set to "sequential positioning," positioning of the next data number in sequence is performed every time a START signal is input.

Speed Control Operation

The motor operates continuously while a FWD signal or RVS signal is input. Because it operates at the speed of the operating data set beforehand, multistep speed-change operation is possible by changing the data number.

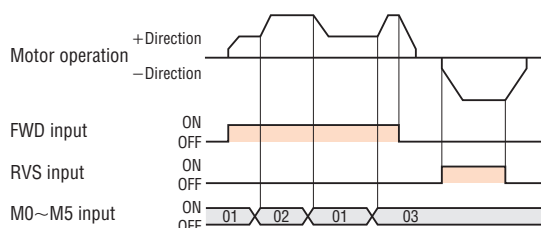

Return to Home Operation

Return to Home Operation can easily be performed by a home position sensor or a sensor representing a position reference point (home) is available.

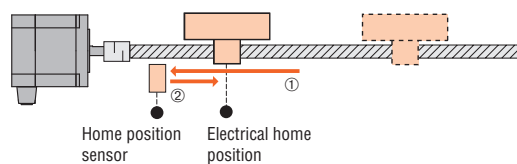

Convenient Functions

PLS-OUT Output Function

Synchronism is available

The PLS-OUT output and DIR-OUT output are used to output the driver's internal oscillation pulse to a second driver allowing for the second motor to be controlled in synchronism with the first. The number of pulses to the output corresponds to the commanded travel and the pulse frequency corresponds to the operating speed.

Used for Position Counting

By counting the output signals, the commanded position of the motor can be checked.

Group Sending Function (RS-485 Communication)

Groups can be configured with multiple axes connected via RS-485 communication, and commands sent for each group. Multi-axis simultaneous starting and identical operations are also possible.

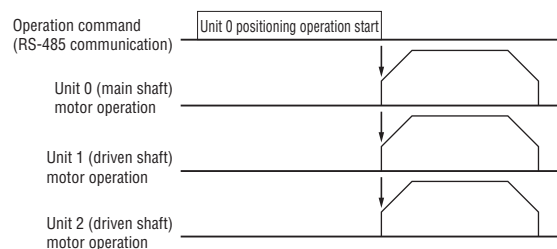





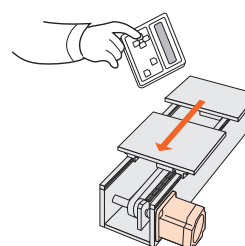

Teaching Function

Teaching can be performed with control module (**OPX-2A**, sold separately) or with the Motion Creator Software (**MEXE02**, sold separately). When you move the table to the target position, it stores the achieved position as positioning data.

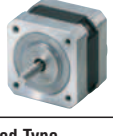

Lineup of Motors

Characteristics Comparison for Motors

Type	Features	Permissible Torque/ Maximum Torque [N·m]	Backlash [arc min (degrees)]	Basic Resolution [deg/step]	Output Shaft Speed [r/min]	
High-Resolution Type 	<ul style="list-style-type: none"> The basic step angle is 0.36°/step, which is half that of the standard type High positioning accuracy 	Maximum Holding Torque 2.3	—	0.36	4000	
High-Torque Type 	<ul style="list-style-type: none"> Higher torque of approximately 1.3 to 1.5 times compared with the standard type 	Maximum Holding Torque 0.42	—	0.72	4000	
Standard Type 	<ul style="list-style-type: none"> Basic model of CRK Series 	Maximum Holding Torque 1.66	—	0.72	4000	
Low Backlash	TH Geared Type (Parallel shaft) 	<ul style="list-style-type: none"> A wide variety of low gear ratios for high-speed operation Gear ratios: 3.6, 7.2, 10, 20, 30 	4	60 (1)	0.024	500
	PS Geared Type (Planetary gear) 	<ul style="list-style-type: none"> High speed (low gear ratios) High permissible/maximum torque A wide variety of gear ratios for selecting the desired step angle Centered output shaft Gear ratios: 5, 7.2, 10, 25, 36, 50 	Permissible Torque 8 Maximum Torque 20	35 (0.59)	0.0144	600
Non-Backlash	PN Geared Type (Planetary gear) 	<ul style="list-style-type: none"> High speed (low gear ratios), high accuracy positioning High permissible/maximum torque A wide variety of gear ratios for selecting the desired step angle Centered output shaft Gear ratios: 5, 7.2, 10, 25, 36, 50 	Permissible Torque 8 Maximum Torque 20	3 (0.05)	0.0144	600
	Harmonic Geared Type (Harmonic drive) 	<ul style="list-style-type: none"> High accuracy positioning High permissible/maximum torque High gear ratios, high resolution Centered output shaft Gear ratios: 50, 100 	Permissible Torque 8 Maximum Torque 28	0	0.0072	70

Note

● The values shown above must be used as reference. The actual values vary depending on the motor frame size and gear ratio.

Wide Variety

The following motor frame sizes are available, depending on whether a built-in controller package or pulse input package is used. ("□42" indicates a motor frame size of 42 mm.)

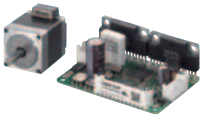
	High-Resolution Type	High-Torque Type	Standard Type	TH Geared Type	PS Geared Type	PN Geared Type	Harmonic Geared Type
Built-In Controller Packages 	□28*1 □42 □60	□20 □28*1 □42	□42*2 □60*2	□28 □42 □60	□28 □42 □60	□28 □42 □60	□20 □30 □42 □60
Pulse Input Packages 	□28*1 □42 □60	□20 □28*1 □42	□42 □60	□28 □42 □60	□28 □42 □60	□28 □42 □60	□20 □30 □42 □60

*1 High-speed specifications are available.

*2 An electromagnetic brake type and an encoder type are available.

System Configuration

Built-In Controller Packages

An example of a configuration when used with either I/O control or RS-485 communication.

*1 Not supplied

*2 Required for driving I/O control.

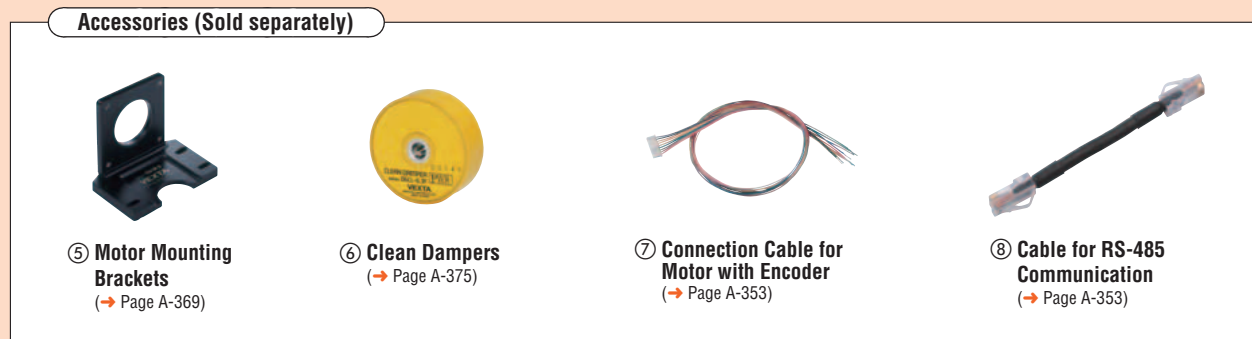
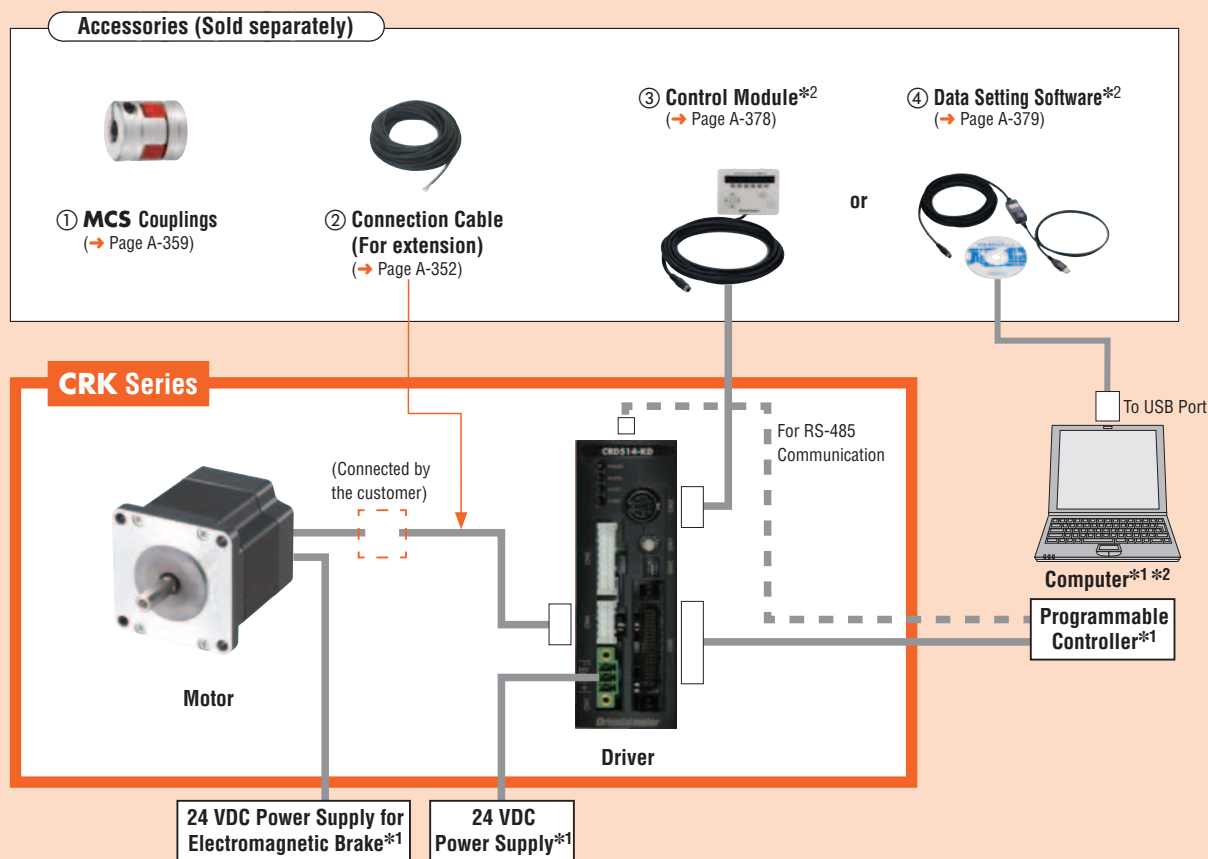

Number	Name	Overview
①	MCS Couplings	Coupling that connects the motor shaft to the driven shaft.
②	Connection Cables (For extension)	These cables are used to extend the wiring distance between the motor and driver (5 m, 10 m). Keep the wiring distance between the motor and driver to 10 m max.
③	Control Module	This control module lets you set (edit, monitor, operate) various data and enables extended functions. Comes with a communication cable (5 m).
④	Data Setting Software	This data setting software lets you set (edit, monitor, operate) various data and enables extended functions. Comes with a PC interface cable (5 m) and a USB cable (0.5 m).
⑤	Motor Mounting Brackets	Dedicated mounting bracket for the motor.
⑥	Clean Dampers	Dedicated damper for suppressing stepping motor vibration.
⑦	Connection Cable for Motor with Encoder	A lead wire type connection cable with a connector crimped, used to connect the encoder and driver. (If an encoder package is purchased, a 0.6 m connection cable is included.)
⑧	Cable for RS-485 Communication	This cable is used to link drivers in a multi-drop manner.

System Configuration Example

CRK Series	Sold Separately				
	Control Module	Connection Cable (5 m)	Motor Mounting Bracket	Flexible Coupling	Clean Damper
CRK566BKD	OPX-2A	CC05PK5	PAL2P-5	MCS200810	D6CL-8.0F

●The system configuration shown above is an example. Other combinations are available.

System Configuration

Pulse Input Packages

An example of a system configuration with the **SG8030JY** controller.

*Not supplied

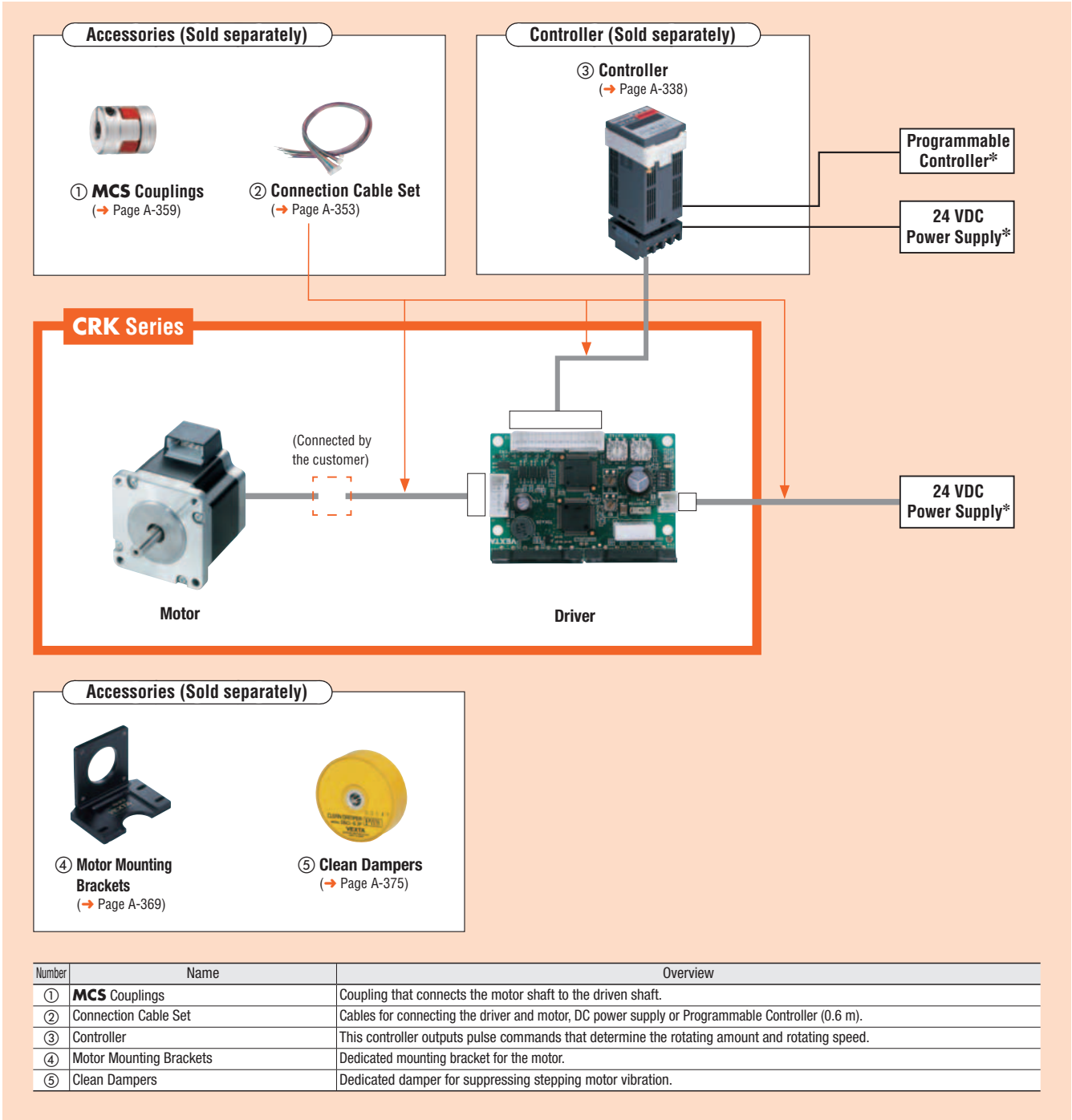

System Configuration Example

CRK Series	Sold Separately				
	Controller	Motor Mounting Bracket	Flexible Coupling	Clean Damper	Connection Cable Set (0.6 m)
CRK566PMBP	SG8030JY-U	PAL2P-5	MCS300816	D6CL-8.0F	LCS04SD5

●The system configuration shown above is an example. Other combinations are available.

Product Number Code

Built-In Controller Package

◇ High-Resolution Type, High-Torque Type, Standard Type

CRK 5 2 3 H P M A □ K D

① ② ③ ④ ⑤ ⑥ ⑦ ⑧ ⑨ ⑩ ⑪

①	Series Name	CRK: CRK Series
②	5: 5-Phase	
③	Motor Frame Size	1: 20 mm 2: 28 mm 4: 42 mm 6: 60 mm
④	Motor Case Length	
⑤	Motor Specifications	Blank: Standard Specifications H: High-Speed Specifications
⑥	Motor Classification	
⑦	Resolution	Blank: High-Torque Type, Standard Type M: High-Resolution Type
⑧	Motor Shaft Type	A: Single Shaft B: Double Shaft R: With Encoder
⑨	Electromagnetic Brake	Blank: Without Electromagnetic Brake M: With Electromagnetic Brake
⑩	Power Supply Input	K: 24 VDC
⑪	Driver Type	D: Built-In Controller Package

Geared Type

CRK 5 2 3 P A K D - N 7.2

① ② ③ ④ ⑤ ⑥ ⑦ ⑧ ⑨ ⑩

①	Series Name	CRK: CRK Series
②	5: 5-Phase	
③	Motor Frame Size	1: 20 mm 2: 28 mm (30 mm) 4: 42 mm 6: 60 mm
④	Motor Case Length	
⑤	Motor Classification	
⑥	Motor Shaft Type	A: Single Shaft B: Double Shaft
⑦	Power Supply Input	K: 24 VDC
⑧	Driver Type	D: Built-In Controller Package
⑨	Gear Type	T: TH Geared Type PS: PS Geared Type N: PN Geared Type H: Harmonic Geared Type
⑩	Gear Ratio	

Pulse Input Package

◇ High-Resolution Type, High-Torque Type, Standard Type

CRK 5 2 3 H P M A P

① ② ③ ④ ⑤ ⑥ ⑦ ⑧ ⑨

①	Series Name	CRK: CRK Series
②	5: 5-Phase	
③	Motor Frame Size	1: 20 mm 2: 28 mm 4: 42 mm 6: 60 mm
④	Motor Case Length	
⑤	Motor Specifications	Blank: Standard Specifications H: High-Speed Specifications
⑥	Motor Classification	
⑦	Resolution	Blank: High-Torque Type, Standard Type M: High-Resolution Type
⑧	Motor Shaft Type	A: Single Shaft B: Double Shaft
⑨	Signal I/O Mode	P: Photocoupler

Geared Type

CRK 5 2 3 P A P - N 7.2

① ② ③ ④ ⑤ ⑥ ⑦ ⑧ ⑨

①	Series Name	CRK: CRK Series
②	5: 5-Phase	
③	Motor Frame Size	1: 20 mm 2: 28 mm (30 mm) 4: 42 mm 6: 60 mm
④	Motor Case Length	
⑤	Motor Classification	
⑥	Motor Shaft Type	A: Single Shaft B: Double Shaft
⑦	Signal I/O Mode	P: Photocoupler
⑧	Gear Type	T: TH Geared Type PS: PS Geared Type N: PN Geared Type H: Harmonic Geared Type
⑨	Gear Ratio	

Product Line

Built-In Controller Packages

High-Resolution Type

Product Name (Single shaft)	Product Name (Double shaft)
CRK523PMAKD	CRK523PMBKD
CRK524PMAKD	CRK524PMBKD
CRK525PMAKD	CRK525PMBKD
CRK523HPMAKD	CRK523HPMBKD
CRK524HPMAKD	CRK524HPMBKD
CRK525HPMAKD	CRK525HPMBKD
CRK544PMAKD	CRK544PMBKD
CRK546PMAKD	CRK546PMBKD
CRK564PMAKD	CRK564PMBKD
CRK566PMAKD	CRK566PMBKD
CRK569PMAKD	CRK569PMBKD

High-Torque Type

Product Name (Single shaft)	Product Name (Double shaft)
CRK513PAKD	CRK513PBKD
CRK523PAKD	CRK523PBKD
CRK525PAKD	CRK525PBKD
CRK523HPAKD	CRK523HPBKD
CRK525HPAKD	CRK525HPBKD
CRK544PAKD	CRK544PBKD
CRK546PAKD	CRK546PBKD

High-Torque Type with Encoders

Product Name (Single shaft)
CRK513PRKD
CRK523PRKD
CRK525PRKD
CRK523HPRKD
CRK525HPRKD
CRK544PRKD
CRK546PRKD

Standard Type

Product Name (Single shaft)	Product Name (Double shaft)
CRK543AKD	CRK543BKD
CRK544AKD	CRK544BKD
CRK545AKD	CRK545BKD
CRK564AKD	CRK564BKD
CRK566AKD	CRK566BKD
CRK569AKD	CRK569BKD

Standard Type with Electromagnetic Brake

Product Name (Single shaft)
CRK543AMKD
CRK544AMKD
CRK545AMKD
CRK564AMKD
CRK566AMKD
CRK569AMKD

Standard Type with Encoders

Product Name (Double shaft)
CRK543RKD
CRK544RKD
CRK545RKD
CRK564RKD
CRK566RKD
CRK569RKD

TH Geared Type

Product Name (Single shaft)	Product Name (Double shaft)
CRK523PAKD-T7.2	CRK523PBKD-T7.2
CRK523PAKD-T10	CRK523PBKD-T10
CRK523PAKD-T20	CRK523PBKD-T20
CRK523PAKD-T30	CRK523PBKD-T30
CRK543AKD-T3.6	CRK543BKD-T3.6
CRK543AKD-T7.2	CRK543BKD-T7.2
CRK543AKD-T10	CRK543BKD-T10
CRK543AKD-T20	CRK543BKD-T20
CRK543AKD-T30	CRK543BKD-T30
CRK564AKD-T3.6	CRK564BKD-T3.6
CRK564AKD-T7.2	CRK564BKD-T7.2
CRK564AKD-T10	CRK564BKD-T10
CRK564AKD-T20	CRK564BKD-T20
CRK564AKD-T30	CRK564BKD-T30

PS Geared Type

Product Name (Single shaft)	Product Name (Double shaft)
CRK523PAKD-PS5	CRK523PBKD-PS5
CRK523PAKD-PS7	CRK523PBKD-PS7
CRK523PAKD-PS10	CRK523PBKD-PS10
CRK545AKD-PS5	CRK545BKD-PS5
CRK545AKD-PS7	CRK545BKD-PS7
CRK545AKD-PS10	CRK545BKD-PS10
CRK543AKD-PS25	CRK543BKD-PS25
CRK543AKD-PS36	CRK543BKD-PS36
CRK543AKD-PS50	CRK543BKD-PS50
CRK566AKD-PS5	CRK566BKD-PS5
CRK566AKD-PS7	CRK566BKD-PS7
CRK566AKD-PS10	CRK566BKD-PS10
CRK564AKD-PS25	CRK564BKD-PS25
CRK564AKD-PS36	CRK564BKD-PS36
CRK564AKD-PS50	CRK564BKD-PS50

PN Geared Type

Product Name (Single shaft)	Product Name (Double shaft)
CRK523PAKD-N5	CRK523PBKD-N5
CRK523PAKD-N7.2	CRK523PBKD-N7.2
CRK523PAKD-N10	CRK523PBKD-N10
CRK544AKD-N5	CRK544BKD-N5
CRK544AKD-N7.2	CRK544BKD-N7.2
CRK544AKD-N10	CRK544BKD-N10
CRK566AKD-N5	CRK566BKD-N5
CRK566AKD-N7.2	CRK566BKD-N7.2
CRK566AKD-N10	CRK566BKD-N10
CRK564AKD-N25	CRK564BKD-N25
CRK564AKD-N36	CRK564BKD-N36
CRK564AKD-N50	CRK564BKD-N50

Harmonic Geared Type

Product Name (Single shaft)	Product Name (Double shaft)
CRK513PAKD-H50	CRK513PBKD-H50
CRK513PAKD-H100	CRK513PBKD-H100
CRK523PAKD-H50	CRK523PBKD-H50
CRK523PAKD-H100	CRK523PBKD-H100
CRK543AKD-H50	CRK543BKD-H50
CRK543AKD-H100	CRK543BKD-H100
CRK564AKD-H50	CRK564BKD-H50
CRK564AKD-H100	CRK564BKD-H100

The following items are included in each product.

Motor, Parallel Key*1, Driver, Power Supply Connector, CN2 Connection Cable, CN4 Connection Cable, Surge Suppressor*2, CN5 Connection Cable*3, Connection Cable*4, Encoder Connection Cable*5, Operating Manual

*1 Only for products with a key slot on the output shaft.

*2 Only for electromagnetic brake type.

*3 Only for encoder type.

*4 Only for connector-coupled motor.

*5 Only for encoder type frame size 20 mm and 28 mm.

● Pulse Input Packages

◇ High-Resolution Type

Product Name (Single shaft)	Product Name (Double shaft)
CRK523PMAP	CRK523PMBP
CRK524PMAP	CRK524PMBP
CRK525PMAP	CRK525PMBP
CRK523HPMAP	CRK523HPMBP
CRK524HPMAP	CRK524HPMBP
CRK525HPMAP	CRK525HPMBP
CRK544PMAP	CRK544PMBP
CRK546PMAP	CRK546PMBP
CRK564PMAP	CRK564PMBP
CRK566PMAP	CRK566PMBP
CRK569PMAP	CRK569PMBP

◇ High-Torque Type

Product Name (Single shaft)	Product Name (Double shaft)
CRK513PAP	CRK513PBP
CRK523PAP	CRK523PBP
CRK525PAP	CRK525PBP
CRK523HPAP	CRK523HPBP
CRK525HPAP	CRK525HPBP
CRK544PAP	CRK544PBP
CRK546PAP	CRK546PBP

◇ Standard Type

Product Name (Single shaft)	Product Name (Double shaft)
CRK543AP	CRK543BP
CRK544AP	CRK544BP
CRK545AP	CRK545BP
CRK564AP	CRK564BP
CRK566AP	CRK566BP
CRK569AP	CRK569BP

◇ TH Geared Type

Product Name (Single shaft)	Product Name (Double shaft)
CRK523PAP-T7.2	CRK523PBP-T7.2
CRK523PAP-T10	CRK523PBP-T10
CRK523PAP-T20	CRK523PBP-T20
CRK523PAP-T30	CRK523PBP-T30
CRK543AP-T3.6	CRK543BP-T3.6
CRK543AP-T7.2	CRK543BP-T7.2
CRK543AP-T10	CRK543BP-T10
CRK543AP-T20	CRK543BP-T20
CRK543AP-T30	CRK543BP-T30
CRK564AP-T3.6	CRK564BP-T3.6
CRK564AP-T7.2	CRK564BP-T7.2
CRK564AP-T10	CRK564BP-T10
CRK564AP-T20	CRK564BP-T20
CRK564AP-T30	CRK564BP-T30

◇ PS Geared Type

Product Name (Single shaft)	Product Name (Double shaft)
CRK523PAP-PS5	CRK523PBP-PS5
CRK523PAP-PS7	CRK523PBP-PS7
CRK523PAP-PS10	CRK523PBP-PS10
CRK545AP-PS5	CRK545BP-PS5
CRK545AP-PS7	CRK545BP-PS7
CRK545AP-PS10	CRK545BP-PS10
CRK543AP-PS25	CRK543BP-PS25
CRK543AP-PS36	CRK543BP-PS36
CRK543AP-PS50	CRK543BP-PS50
CRK566AP-PS5	CRK566BP-PS5
CRK566AP-PS7	CRK566BP-PS7
CRK566AP-PS10	CRK566BP-PS10
CRK564AP-PS25	CRK564BP-PS25
CRK564AP-PS36	CRK564BP-PS36
CRK564AP-PS50	CRK564BP-PS50

◇ PN Geared Type

Product Name (Single shaft)	Product Name (Double shaft)
CRK523PAP-N5	CRK523PBP-N5
CRK523PAP-N7.2	CRK523PBP-N7.2
CRK523PAP-N10	CRK523PBP-N10
CRK544AP-N5	CRK544BP-N5
CRK544AP-N7.2	CRK544BP-N7.2
CRK544AP-N10	CRK544BP-N10
CRK566AP-N5	CRK566BP-N5
CRK566AP-N7.2	CRK566BP-N7.2
CRK566AP-N10	CRK566BP-N10
CRK564AP-N25	CRK564BP-N25
CRK564AP-N36	CRK564BP-N36
CRK564AP-N50	CRK564BP-N50

◇ Harmonic Geared Type

Product Name (Single shaft)	Product Name (Double shaft)
CRK513PAP-H50	CRK513PBP-H50
CRK513PAP-H100	CRK513PBP-H100
CRK523PAP-H50	CRK523PBP-H50
CRK523PAP-H100	CRK523PBP-H100
CRK543AP-H50	CRK543BP-H50
CRK543AP-H100	CRK543BP-H100
CRK564AP-H50	CRK564BP-H50
CRK564AP-H100	CRK564BP-H100

The following items are included in each product.

Motor, Parallel Key*1, Driver, Driver Connector, Connection Cable*2, Operating Manual

*1 Only for the products with a key slot on the output shaft.

*2 Only for connector-coupled motor.

High-Resolution Type Frame Size 28 mm

Specifications RoHS



Product Name	Built-In Controller Package	Single Shaft	CRK523PMAKD	CRK524PMAKD	CRK525PMAKD	CRK523HPMAKD	CRK524HPMAKD	CRK525HPMAKD
		Double Shaft	CRK523PMBKD	CRK524PMBKD	CRK525PMBKD	CRK523HPMBKD	CRK524HPMBKD	CRK525HPMBKD
	Pulse Input Package	Single Shaft	CRK523PMAP	CRK524PMAP	CRK525PMAP	CRK523HPMAP	CRK524HPMAP	CRK525HPMAP
		Double Shaft	CRK523PMBP	CRK524PMBP	CRK525PMBP	CRK523HPMBP	CRK524HPMBP	CRK525HPMBP
Maximum Holding Torque		N·m	0.042	0.061	0.09	0.038	0.061	0.081
Holding Torque at Motor Standstill Power ON		N·m	0.019	0.028	0.041	0.019	0.03	0.04
Rotor Inertia		J: kg·m ²	9×10 ⁻⁷	13×10 ⁻⁷	19×10 ⁻⁷	9×10 ⁻⁷	13×10 ⁻⁷	19×10 ⁻⁷
Rated Current		A/Phase	0.35			0.75		
Basic Step Angle						0.36°		
Power Supply Input	24 VDC±10% 0.7 A					24 VDC±10% 1.4 A		
Excitation Mode	Microstep							

● A connection cable (0.6 m) is included with the connector-coupled motor and driver package.
*Certification for UL standards is only acquired on pulse input package.

Speed – Torque Characteristics

CRK523PM

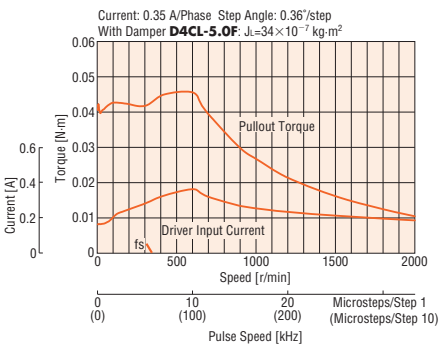

CRK524PM

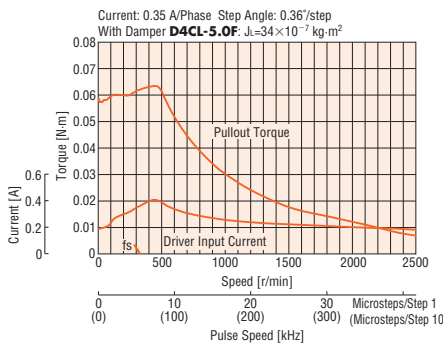

CRK525PM

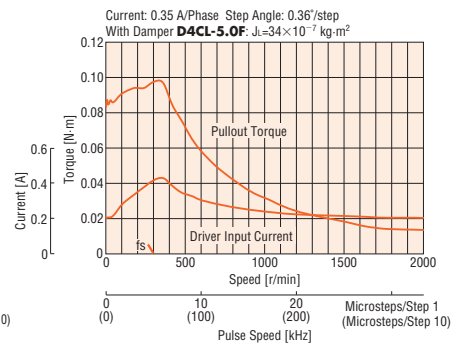

CRK523HPM

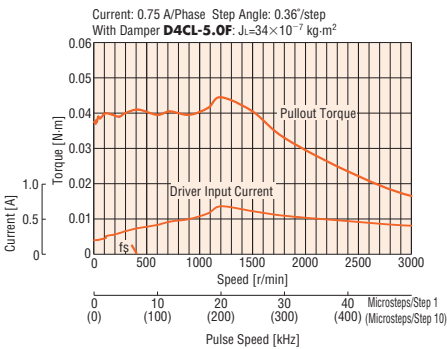

CRK524HPM

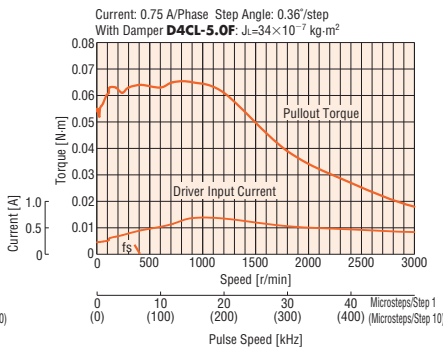

CRK525HPM

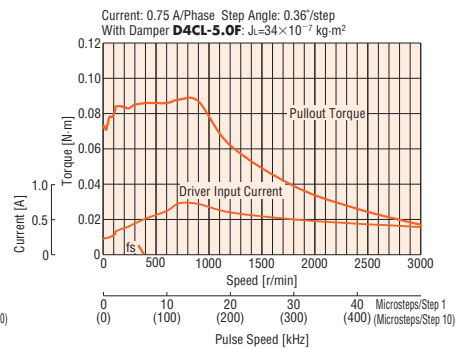

● The pulse input circuit responds to approximately 500 kHz with a pulse duty of 50%.

Note

● Depending on the driving conditions, a considerable amount of heat may be generated by the motor. Be sure to keep the motor case temperature at 100°C or less.
[When conforming to the UL or CSA Standards, it is required to keep the temperature of the motor case at 75°C or less, since the motor is recognized as thermal class 105 (A).]

High-Resolution Type Frame Size 42 mm, 60 mm

Specifications RoHS



Product Name	Built-In Controller Package		CRK544PMAKD	CRK546PMAKD	CRK564PMAKD	CRK566PMAKD	CRK569PMAKD
	Single Shaft	Double Shaft	CRK544PMBKD	CRK546PMBKD	CRK564PMBKD	CRK566PMBKD	CRK569PMBKD
	Pulse Input Package		CRK544PMAP	CRK546PMAP	CRK564PMAP	CRK566PMAP	CRK569PMAP
	Double Shaft		CRK544PMBP	CRK546PMBP	CRK564PMBP	CRK566PMBP	CRK569PMBP
Maximum Holding Torque	N·m		0.24	0.42	0.78	1.3	2.3
Holding Torque at Motor Standstill	Power ON		0.11	0.19	0.35	0.58	1
Rotor Inertia	J: kg·m ²		60×10 ⁻⁷	121×10 ⁻⁷	310×10 ⁻⁷	490×10 ⁻⁷	970×10 ⁻⁷
Rated Current	A/Phase		0.75			1.4	
Basic Step Angle			0.36°				
Power Supply Input			24 VDC±10% 1.4 A			24 VDC±10% 2.5 A	
Excitation Mode			Microstep				

● A connection cable (0.6 m) is included with the connector-coupled motor and driver package.
 *Certification for UL standards is only acquired on pulse input package.

Speed – Torque Characteristics

CRK544PM

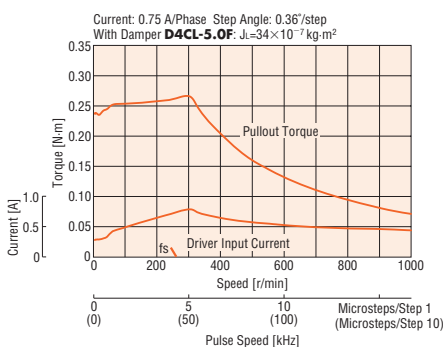

CRK546PM

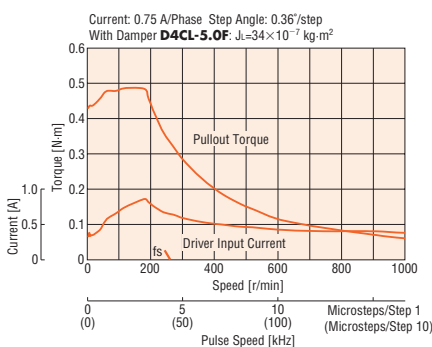

CRK564PM

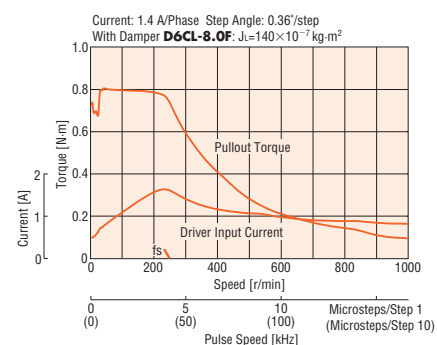

CRK566PM

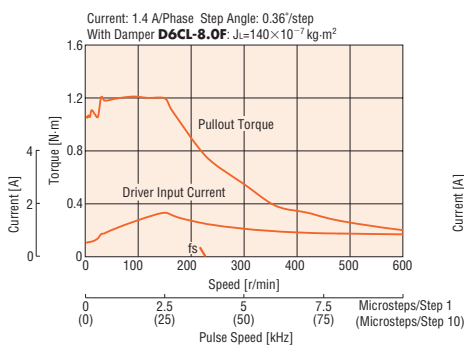

CRK569PM

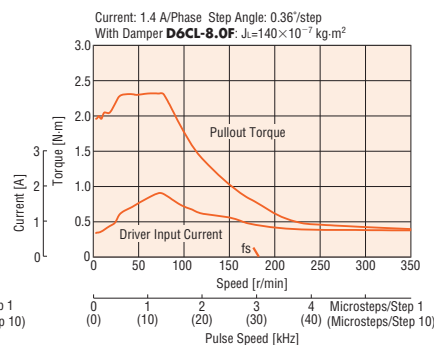

● The pulse input circuit responds to approximately 500 kHz with a pulse duty of 50%.

Note

● Depending on the driving conditions, a considerable amount of heat may be generated by the motor. Be sure to keep the motor case temperature at 100°C or less.
 [When conforming to the UL or CSA Standards, it is required to keep the temperature of the motor case at 75°C or less, since the motor is recognized as thermal class 105 (A).]

High-Torque Type Frame Size 20 mm, 28 mm

High-Torque Type with Encoder Frame Size 20 mm, 28 mm

Specifications (RoHS)



Product Name	Built-In Controller Package	Single Shaft	CRK513PAKD	CRK523PAKD	CRK525PAKD	CRK523HPAKD	CRK525HPAKD
		Double Shaft	CRK513PBKD	CRK523PBKD	CRK525PBKD	CRK523HPBKD	CRK525HPBKD
		With Encoder	CRK513PRKD	CRK523PRKD	CRK525PRKD	CRK523HPRKD	CRK525HPRKD
		Pulse Input Package	CRK513PAP	CRK523PAP	CRK525PAP	CRK523HPAP	CRK525HPAP
		Double Shaft	CRK513PBP	CRK523PBP	CRK525PBP	CRK523HPBP	CRK525HPBP
Maximum Holding Torque		N·m	0.0231	0.048	0.078	0.041	0.073
Holding Torque at Motor Standstill	Power ON	N·m	0.011	0.023	0.037	0.02	0.036
Rotor Inertia		J: kg·m ²	1.6×10 ⁻⁷ [1.7×10 ⁻⁷]	9×10 ⁻⁷	18×10 ⁻⁷	9×10 ⁻⁷	18×10 ⁻⁷
Rated Current		A/Phase	0.35			0.75	
Basic Step Angle			0.72°				
Power Supply Input			24 VDC±10%	0.7 A	24 VDC±10% 1.4 A		
Excitation Mode			Microstep				

- A connection cable (0.6 m) is included with the connector-coupled motor and driver package.
- The brackets [] indicate the specification for the encoder type.
- *Certification for UL standards is only acquired on pulse input package.

Speed – Torque Characteristics

CRK513P

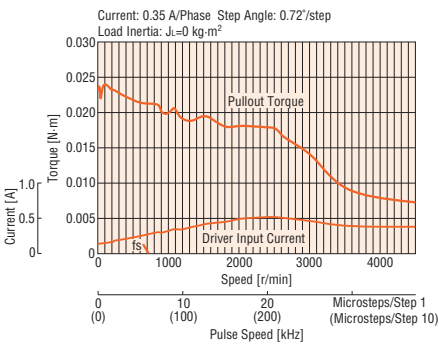

CRK523P

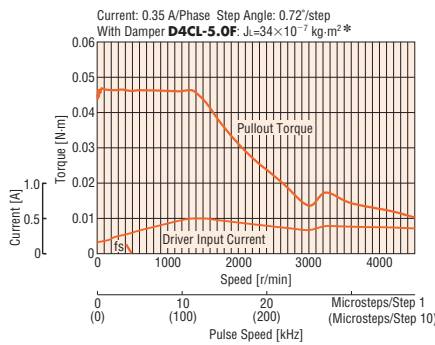

CRK525P

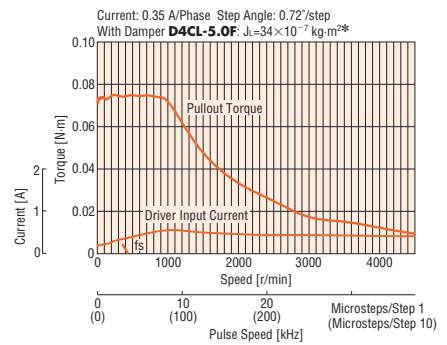

CRK523HP

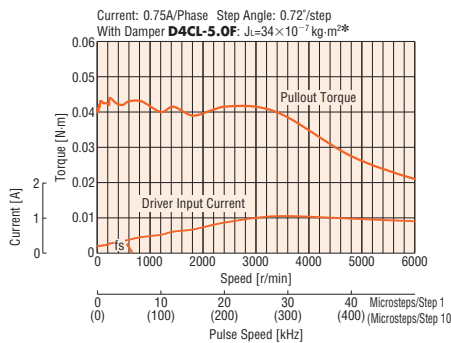

CRK525HP

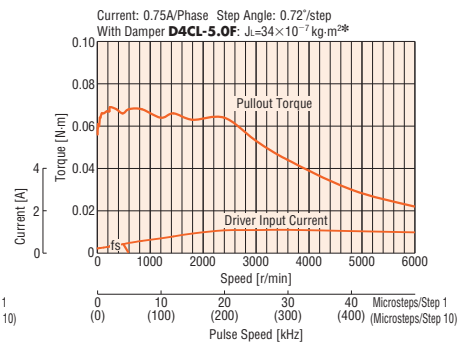

- *For motor with an encoder, a load with a similar inertia should be attached.
- The pulse input circuit responds to approximately 500 kHz with a pulse duty of 50%.

Note

- Depending on the driving conditions, a considerable amount of heat may be generated by the motor. Be sure to keep the motor case temperature at 100°C or less. [When conforming to the UL or CSA Standards, it is required to keep the temperature of the motor case at 75°C or less, since the motor is recognized as thermal class 105 (A).]
- Be sure to keep the encoder case temperature at 85°C or less.

High-Torque Type Frame Size 42 mm

High-Torque Type with Encoder Frame Size 42 mm

Specifications RoHS



Product Name	Built-In Controller Package		CRK544PAKD	CRK546PAKD
	Single Shaft	Double Shaft	CRK544PBKD	CRK546PBKD
Pulse Input Package	With Encoder		CRK544PRKD	CRK546PRKD
	Single Shaft	Double Shaft	CRK544PAP	CRK546PAP
			CRK544PBP	CRK546PBP
Maximum Holding Torque	N·m		0.24	0.42
Holding Torque at Motor Standstill	Power ON		0.114	0.2
Rotor Inertia	J: kg·m ²		57×10^{-7}	114×10^{-7}
Rated Current	A/Phase		0.75	
Basic Step Angle			0.72°	
Power Supply Input			24 VDC ± 10% 1.4 A	
Excitation Mode			Microstep	

● A connection cable (0.6 m) is included with the connector-coupled motor and driver package.

*Certification for UL standards is only acquired on pulse input package.

Speed – Torque Characteristics

CRK544P

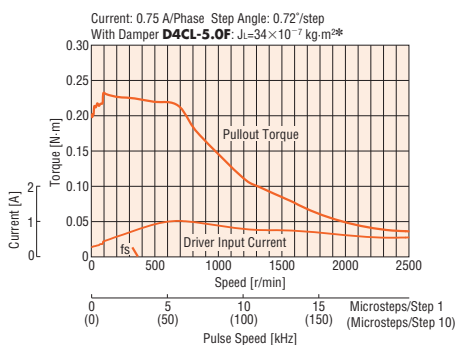

CRK546P

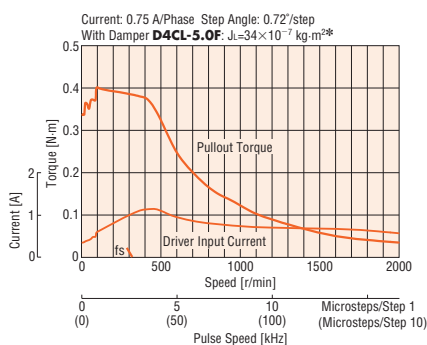

*For motor with an encoder, a load with a similar inertia should be attached.

● The pulse input circuit responds to approximately 500 kHz with a pulse duty of 50%.

Note

● Depending on the driving conditions, a considerable amount of heat may be generated by the motor. Be sure to keep the motor case temperature at 100°C or less.

[When conforming to the UL or CSA Standards, it is required to keep the temperature of the motor case at 75°C or less, since the motor is recognized as thermal class 105 (A).]

● Be sure to keep the encoder case temperature at 80°C or less.

Standard Type Frame Size 42 mm, 60 mm

Standard Type with Encoder Frame Size 42 mm, 60 mm

Specifications RoHS



Product Name	Built-In Controller Package	Single Shaft	CRK543AKD	CRK544AKD	CRK545AKD	CRK564AKD	CRK566AKD	CRK569AKD
		Double Shaft	CRK543BKD	CRK544BKD	CRK545BKD	CRK564BKD	CRK566BKD	CRK569BKD
		With Encoder	CRK543RKD	CRK544RKD	CRK545RKD	CRK564RKD	CRK566RKD	CRK569RKD
Pulse Input Package	Single Shaft		CRK543AP	CRK544AP	CRK545AP	CRK564AP	CRK566AP	CRK569AP
	Double Shaft		CRK543BP	CRK544BP	CRK545BP	CRK564BP	CRK566BP	CRK569BP
Maximum Holding Torque		N·m	0.13	0.18	0.24	0.42	0.83	1.66
Holding Torque at Motor Standstill	Power ON	N·m	0.061	0.085	0.114	0.2	0.38	0.79
Rotor Inertia		J: kg·m ²	35×10 ⁻⁷ [40×10 ⁻⁷]	54×10 ⁻⁷ [59×10 ⁻⁷]	68×10 ⁻⁷ [73×10 ⁻⁷]	175×10 ⁻⁷ [185×10 ⁻⁷]	280×10 ⁻⁷ [290×10 ⁻⁷]	560×10 ⁻⁷ [570×10 ⁻⁷]
Rated Current		A/Phase	0.75			1.4		
Basic Step Angle			0.72°					
Power Supply Voltage			24 VDC±10% 1.4 A			24 VDC±10% 2.5 A		
Excitation Mode			Microstep					

● The brackets [] indicate the specification for the encoder type.

*Certification for UL standards is only acquired on pulse input package.

Speed – Torque Characteristics

CRK543

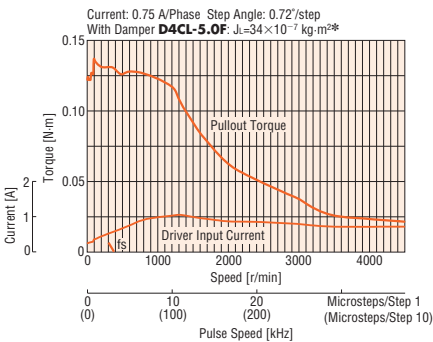

CRK544

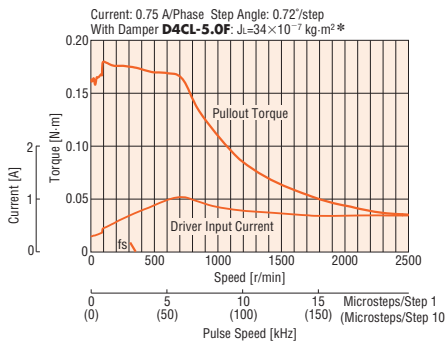

CRK545

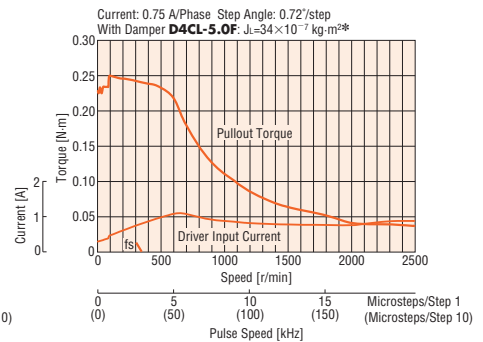

CRK564

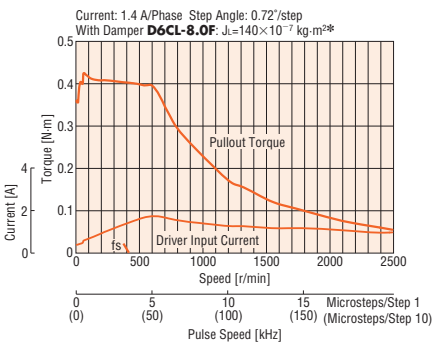

CRK566

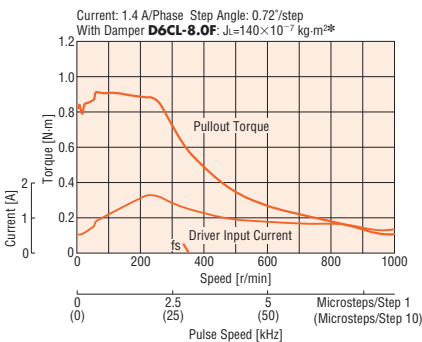

CRK569

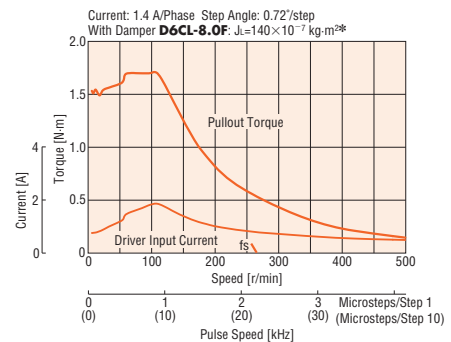

*For motor with an encoder, a load with a similar inertia should be attached.

● The pulse input circuit responds to approximately 500 kHz with a pulse duty of 50%.

Note

● Depending on the driving conditions, a considerable amount of heat may be generated by the motor. Be sure to keep the motor case temperature at 100°C or less.

[When conforming to the UL or CSA Standards, it is required to keep the temperature of the motor case at 75°C or less, since the motor is recognized as thermal class 105 (A).]

● Be sure to keep the encoder case temperature at 80°C or less.

Standard Type with Electromagnetic Brake Frame Size 42 mm, 60 mm

Specifications



Product Name	Built-In Controller Package	Single Shaft	CRK543AMKD	CRK544AMKD	CRK545AMKD	CRK564AMKD	CRK566AMKD	CRK569AMKD
Maximum Holding Torque		N·m	0.13	0.18	0.24	0.42	0.83	1.66
Holding Torque at Motor Standstill	Power ON	N·m	0.061	0.085	0.114	0.2	0.38	0.79
	Electromagnetic Brake	N·m	0.061	0.085	0.114	0.2	0.38	0.79
Rotor Inertia		J: kg·m ²	50×10 ⁻⁷	69×10 ⁻⁷	83×10 ⁻⁷	335×10 ⁻⁷	440×10 ⁻⁷	720×10 ⁻⁷
Rated Current		A/Phase	0.75			1.4		
Basic Step Angle			0.72°					
Power Supply Voltage			24 VDC±10% 1.4 A			24 VDC±10% 2.5 A		
Excitation Mode	Type		Microstep					
	Power Supply Voltage		24 VDC±5%					
Electromagnetic Brake	Power Supply Current	A	0.08			0.25		
	Brake Operating Time	ms	20					
	Brake Release Time	ms	30					
	Time Rating		Continuous					

Speed – Torque Characteristics

CRK543AM

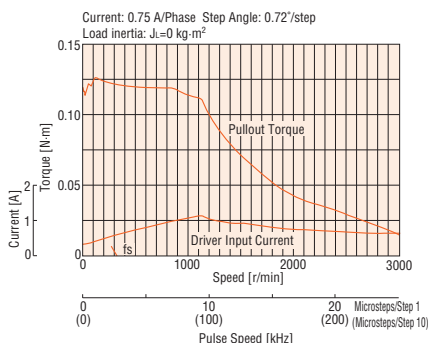

CRK544AM

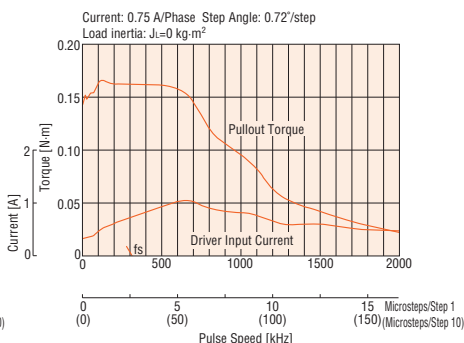

CRK545AM

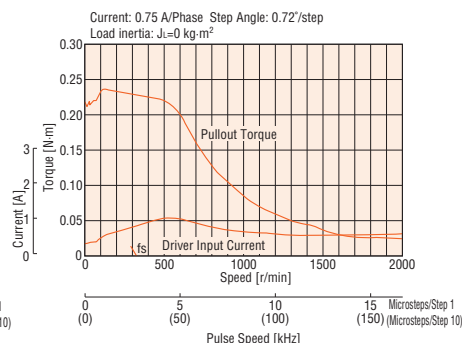

CRK564AM

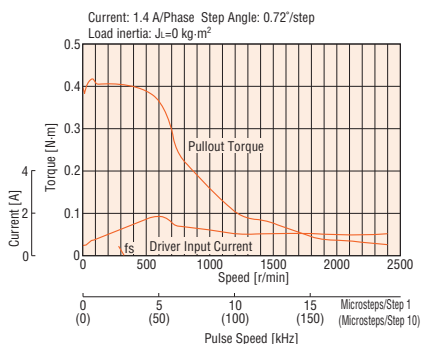

CRK566AM

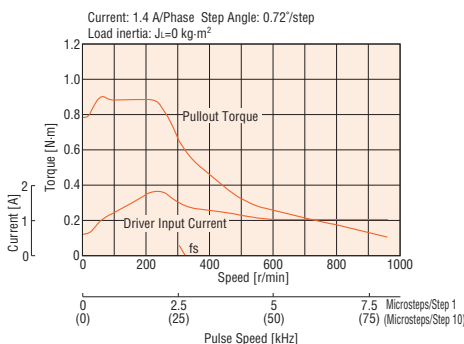

CRK569AM

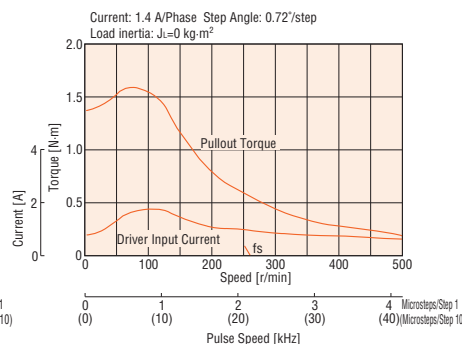

● Depending on the driving conditions, a considerable amount of heat may be generated by the motor. Be sure to keep the motor case temperature at 100°C or less.

TH Geared Type Frame Size 28 mm

Specifications RoHS



Product Name	Built-In Controller Package		CRK523PAKD-T7.2	CRK523PAKD-T10	CRK523PAKD-T20	CRK523PAKD-T30
	Pulse Input Package	Single Shaft	CRK523PBKD-T7.2	CRK523PBKD-T10	CRK523PBKD-T20	CRK523PBKD-T30
		Double Shaft	CRK523PAP-T7.2	CRK523PAP-T10	CRK523PAP-T20	CRK523PAP-T30
		Double Shaft	CRK523PBP-T7.2	CRK523PBP-T10	CRK523PBP-T20	CRK523PBP-T30
Maximum Holding Torque	N-m		0.2	0.3	0.4	0.5
Rotor Inertia	J: kg-m ²		9×10 ⁻⁷			
Rated Current	A/Phase		0.35			
Basic Step Angle			0.1°	0.072°	0.036°	0.024°
Gear Ratio			7.2	10	20	30
Permissible Torque	N-m		0.2	0.3	0.4	0.5
Holding Torque at Motor Standstill	Power ON		0.17	0.24	0.4	0.5
Backlash	arc minute		60 (1°)			
Permissible Speed Range	r/min		0~416	0~300	0~150	0~100
Power Supply Voltage			24 VDC±10% 0.7 A			
Excitation Mode			Microstep			

● A connection cable (0.6 m) is included with the connector-coupled motor and driver package.

*Certification for UL standards is only acquired on pulse input package.

Speed – Torque Characteristics

CRK523 Gear Ratio 7.2

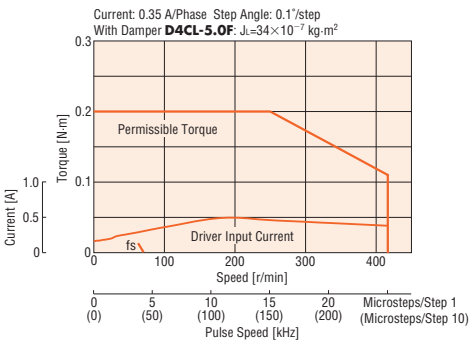

CRK523 Gear Ratio 10

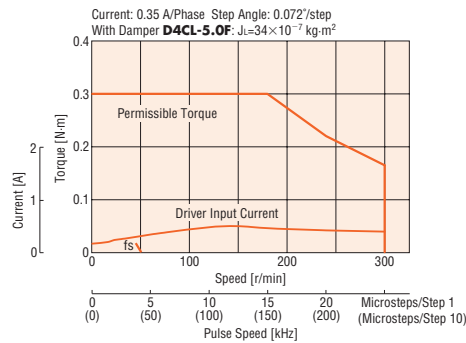

CRK523 Gear Ratio 20

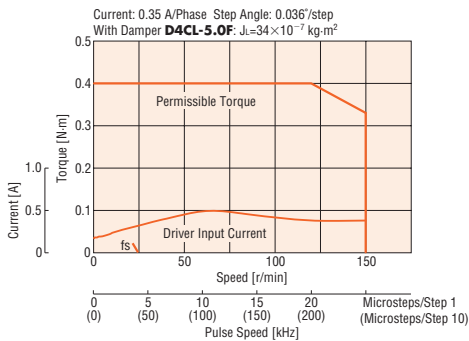

CRK523 Gear Ratio 30

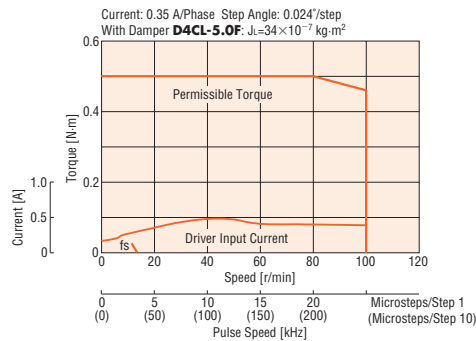

● The pulse input circuit responds to approximately 500 kHz with a pulse duty of 50%.

Note

● Depending on the driving conditions, a considerable amount of heat may be generated by the motor. Be sure to keep the motor case temperature at 100°C or less.
[When conforming to the UL or CSA Standards, it is required to keep the temperature of the motor case at 75°C or less, since the motor is recognized as thermal class 105 (A).]

TH Geared Type Frame Size 42 mm

Specifications RoHS



Product Name	Built-In Controller Package	Single Shaft	CRK543AKD-T3.6	CRK543AKD-T7.2	CRK543AKD-T10	CRK543AKD-T20	CRK543AKD-T30
		Double Shaft	CRK543BKD-T3.6	CRK543BKD-T7.2	CRK543BKD-T10	CRK543BKD-T20	CRK543BKD-T30
	Pulse Input Package	Single Shaft	CRK543AP-T3.6	CRK543AP-T7.2	CRK543AP-T10	CRK543AP-T20	CRK543AP-T30
	Double Shaft		CRK543BP-T3.6	CRK543BP-T7.2	CRK543BP-T10	CRK543BP-T20	CRK543BP-T30
Maximum Holding Torque		N·m	0.35	0.7	1	1.5	
Rotor Inertia		J: kg·m ²	35 × 10 ⁻⁷				
Rated Current		A/Phase	0.75				
Basic Step Angle			0.2°	0.1°	0.072°	0.036°	0.024°
Gear Ratio			3.6	7.2	10	20	30
Permissible Torque		N·m	0.35	0.7	1	1.5	
Holding Torque at Motor Standstill	Power ON	N·m	0.23	0.46	0.65	1.3	1.5
Backlash		arc minute	45 (0.75°)	25 (0.42°)		15 (0.25°)	
Permissible Speed Range		r/min	0~500	0~250	0~180	0~90	0~60
Power Supply Voltage			24 VDC ± 10% 1.4 A				
Excitation Mode			Microstep				

*Certification for UL standards is only acquired on pulse input package.

Speed – Torque Characteristics

CRK543 Gear Ratio 3.6

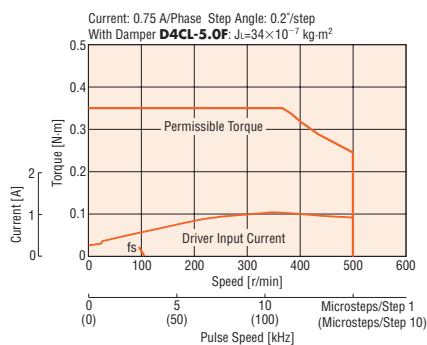

CRK543 Gear Ratio 7.2

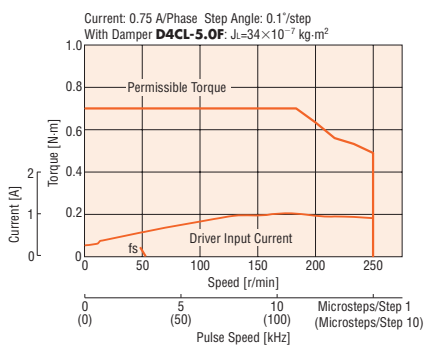

CRK543 Gear Ratio 10

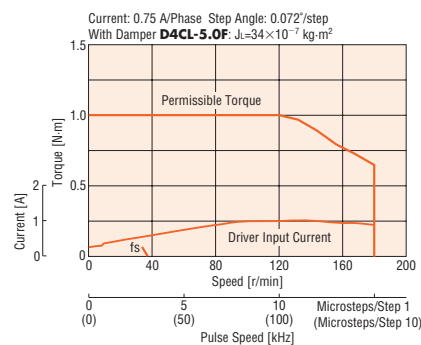

CRK543 Gear Ratio 20

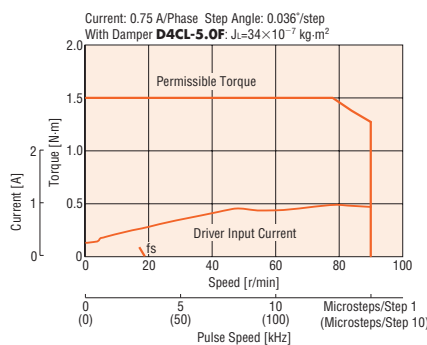

CRK543 Gear Ratio 30

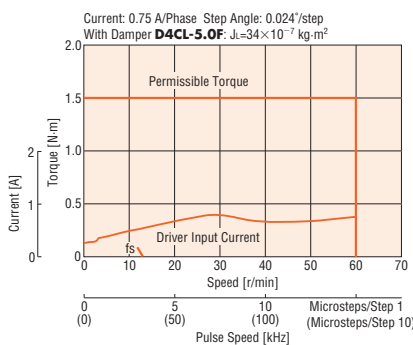

● The pulse input circuit responds to approximately 500 kHz with a pulse duty of 50%.

Note

- Depending on the driving conditions, a considerable amount of heat may be generated by the motor. Be sure to keep the motor case temperature at 100°C or less.
[When conforming to the UL or CSA Standards, it is required to keep the temperature of the motor case at 75°C or less, since the motor is recognized as thermal class 105 (A).]

Introduction
0.36°/Geared
AR
AC Input Motor & Driver
0.72°/Geared
RK
0.36°/Geared
AR
0.36°/10.72°/
Geared
CRK
DC Input Motor & Driver
1.8°/Geared
RK
0.9°/1.8°/Geared
CMK
0.72°
PK
1.8°/Geared
High-Torque
PKP
0.9°/1.8°/Geared
PK
Controllers
SG8030JY
Motor Only
Accessories

TH Geared Type Frame Size 60 mm

Specifications RoHS



Product Name	Built-In Controller Package		Single Shaft	CRK564AKD-T3.6	CRK564AKD-T7.2	CRK564AKD-T10	CRK564AKD-T20	CRK564AKD-T30
	Pulse Input Package		Double Shaft	CRK564BKD-T3.6	CRK564BKD-T7.2	CRK564BKD-T10	CRK564BKD-T20	CRK564BKD-T30
			Single Shaft	CRK564AP-T3.6	CRK564AP-T7.2	CRK564AP-T10	CRK564AP-T20	CRK564AP-T30
			Double Shaft	CRK564BP-T3.6	CRK564BP-T7.2	CRK564BP-T10	CRK564BP-T20	CRK564BP-T30
Maximum Holding Torque			N·m	1.25	2.5	3	3.5	4
Rotor Inertia			J: kg·m ²	175×10 ⁻⁷				
Rated Current			A/Phase	1.4				
Basic Step Angle				0.2°	0.1°	0.072°	0.036°	0.024°
Gear Ratio				3.6	7.2	10	20	30
Permissible Torque			N·m	1.25	2.5	3	3.5	4
Holding Torque at Motor Standstill Power ON			N·m	0.75	1.5	2.1	3.5	4
Backlash			arc minute (degrees)	35 (0.59°)	15 (0.25°)		10 (0.17°)	
Permissible Speed Range			r/min	0~500	0~250	0~180	0~90	0~60
Power Supply Voltage				24 VDC±10% 2.5 A				
Excitation Mode				Microstep				

*Certification for UL standards is only acquired on pulse input package.

Speed – Torque Characteristics

CRK564 Gear Ratio 3.6

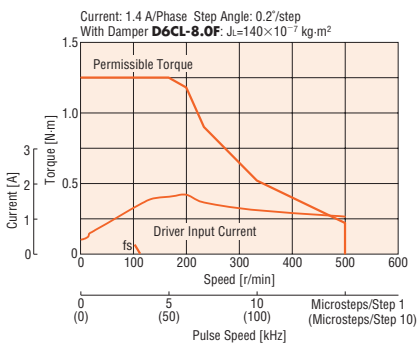

CRK564 Gear Ratio 7.2

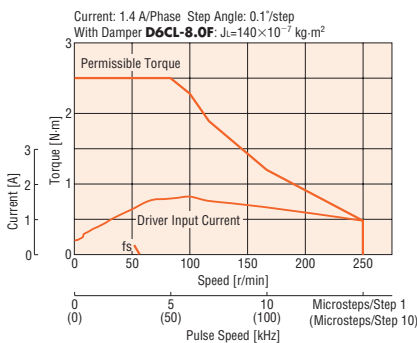

CRK564 Gear Ratio 10

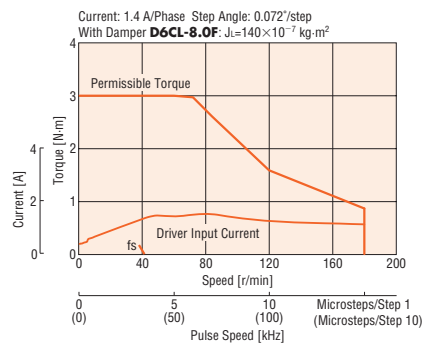

CRK564 Gear Ratio 20

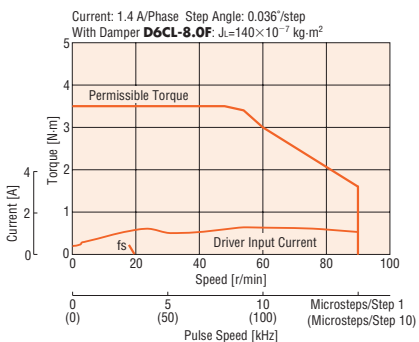

CRK564 Gear Ratio 30

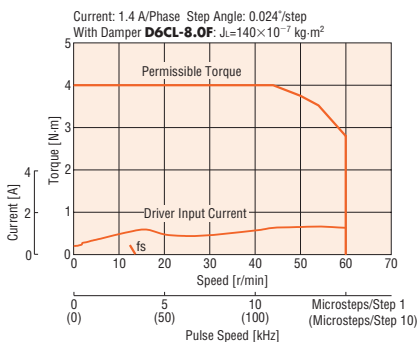

● The pulse input circuit responds to approximately 500 kHz with a pulse duty of 50%.

Note

● Depending on the driving conditions, a considerable amount of heat may be generated by the motor. Be sure to keep the motor case temperature at 100°C or less.
[When conforming to the UL or CSA Standards, it is required to keep the temperature of the motor case at 75°C or less, since the motor is recognized as thermal class 105 (A).]

PS Geared Type Frame Size 28 mm

Specifications RoHS



Product Name	Built-In Controller Package		Single Shaft	CRK523PAKD-PS5	CRK523PAKD-PS7	CRK523PAKD-PS10
	Pulse Input Package		Double Shaft	CRK523PBKD-PS5	CRK523PBKD-PS7	CRK523PBKD-PS10
			Single Shaft	CRK523PAP-PS5	CRK523PAP-PS7	CRK523PAP-PS10
			Double Shaft	CRK523PBP-PS5	CRK523PBP-PS7	CRK523PBP-PS10
Maximum Holding Torque			N-m	0.2	0.3	0.4
Rotor Inertia			J: kg-m ²	9×10 ⁻⁷		
Rated Current			A/Phase	0.35		
Basic Step Angle				0.144°	0.1°	0.072°
Gear Ratio				5	7.2	10
Permissible Torque			N-m	0.2	0.3	0.4
Maximum Torque			N-m	0.5		
Holding Torque at Motor Standstill	Power ON			N-m	0.12	0.17
Backlash			arc minute (degrees)	35 (0.59)		
Permissible Speed Range			r/min	0~600	0~416	0~300
Power Supply Voltage				24 VDC±10% 0.7 A		
Excitation Mode				Microstep		

● A connection cable (0.6 m) is included with the connector-coupled motor and driver package.

*Certification for UL standards is only acquired on pulse input package.

Speed – Torque Characteristics

CRK523 Gear Ratio 5

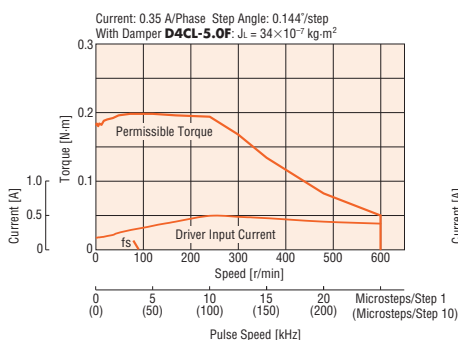

CRK523 Gear Ratio 7.2

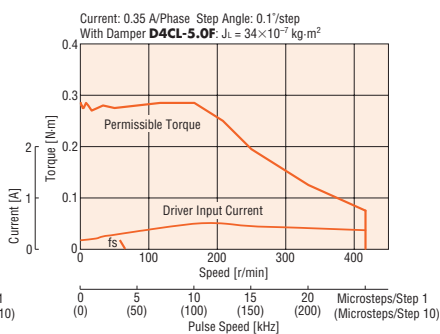

CRK523 Gear Ratio 10

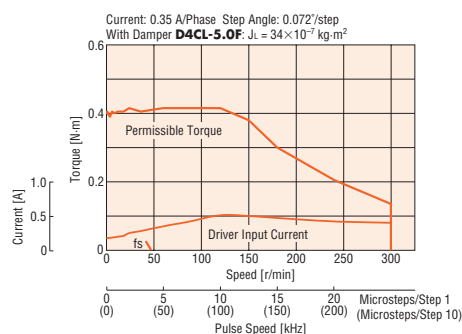

● The pulse input circuit responds to approximately 500 kHz with a pulse duty of 50%.

Note

● Depending on the driving conditions, a considerable amount of heat may be generated by the motor. Be sure to keep the motor case temperature at 100°C or less.
[When conforming to the UL or CSA Standards, it is required to keep the temperature of the motor case at 75°C or less, since the motor is recognized as thermal class 105 (A).]

Introduction

AC Input Motor & Driver

DC Input Motor & Driver

Motor Only

Controllers
SG80301Y

Accessories

PS Geared Type Frame Size 42 mm

Specifications RoHS



Product Name	Built-In Controller Package	Single Shaft	CRK545AKD-PS5	CRK545AKD-PS7	CRK545AKD-PS10	CRK543AKD-PS25	CRK543AKD-PS36	CRK543AKD-PS50
			CRK545BKD-PS5	CRK545BKD-PS7	CRK545BKD-PS10	CRK543BKD-PS25	CRK543BKD-PS36	CRK543BKD-PS50
		Double Shaft	CRK545AP-PS5	CRK545AP-PS7	CRK545AP-PS10	CRK543AP-PS25	CRK543AP-PS36	CRK543AP-PS50
		Single Shaft	CRK545BP-PS5	CRK545BP-PS7	CRK545BP-PS10	CRK543BP-PS25	CRK543BP-PS36	CRK543BP-PS50
		Double Shaft	CRK545BP-PS5	CRK545BP-PS7	CRK545BP-PS10	CRK543BP-PS25	CRK543BP-PS36	CRK543BP-PS50
Maximum Holding Torque		N-m	1	1.5	2.5	3		
Rotor Inertia		J: kg-m ²	68×10 ⁻⁷			35×10 ⁻⁷		
Rated Current		A/Phase	0.75					
Basic Step Angle			0.144°	0.1°	0.072°	0.0288°	0.02°	0.0144°
Gear Ratio			5	7.2	10	25	36	50
Permissible Torque		N-m	1	1.5	2.5	3		
Maximum Torque		N-m	1.5	2	6			
Holding Torque at Motor Standstill Power ON		N-m	0.6	0.86	1.2	1.6	2.3	3
Backlash		arc minute (degrees)	25 (0.42°)					
Permissible Speed Range		r/min	0~600	0~416	0~300	0~120	0~83	0~60
Power Supply Voltage			24 VDC ± 10% 1.4 A					
Excitation Mode			Microstep					

*Certification for UL standards is only acquired on pulse input package.

Speed – Torque Characteristics

CRK545 Gear Ratio 5

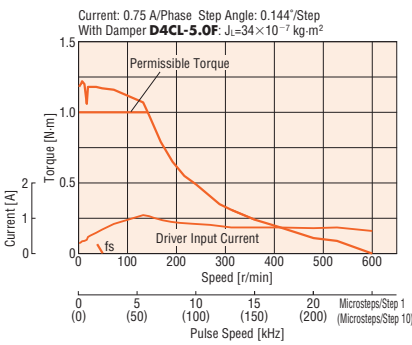

CRK545 Gear Ratio 7.2

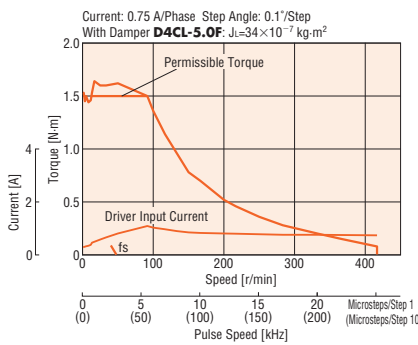

CRK545 Gear Ratio 10

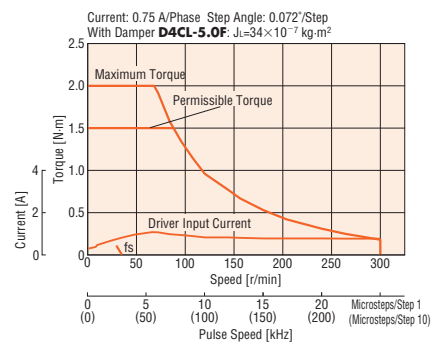

CRK543 Gear Ratio 25

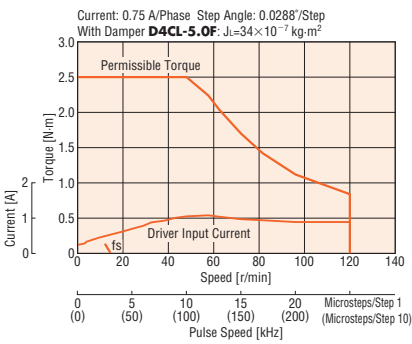

CRK543 Gear Ratio 36

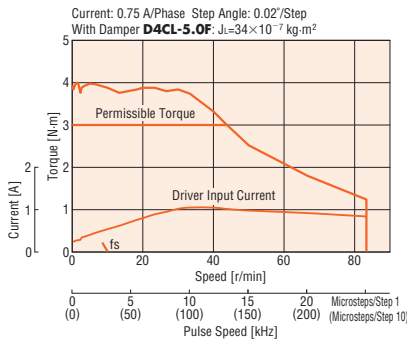

CRK543 Gear Ratio 50

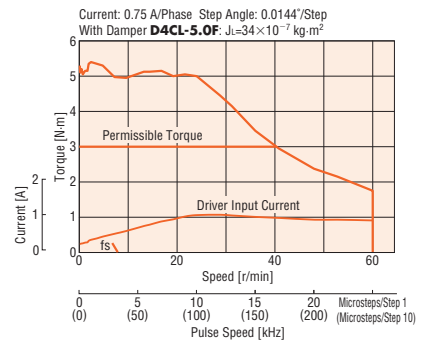

● The pulse input circuit responds to approximately 500 kHz with a pulse duty of 50%.

Note

● Depending on the driving conditions, a considerable amount of heat may be generated by the motor. Be sure to keep the motor case temperature at 100°C or less.
[When conforming to the UL or CSA Standards, it is required to keep the temperature of the motor case at 75°C or less, since the motor is recognized as thermal class 105 (A).]

PS Geared Type Frame Size 60 mm

Specifications (RoHS)



Product Name	Built-in Controller Package		Single Shaft	CRK566AKD-PS5	CRK566AKD-PS7	CRK566AKD-PS10	CRK564AKD-PS25	CRK564AKD-PS36	CRK564AKD-PS50
	Pulse Input Package		Double Shaft	CRK566BKD-PS5	CRK566BKD-PS7	CRK566BKD-PS10	CRK564BKD-PS25	CRK564BKD-PS36	CRK564BKD-PS50
		Single Shaft		CRK566AP-PS5	CRK566AP-PS7	CRK566AP-PS10	CRK564AP-PS25	CRK564AP-PS36	CRK564AP-PS50
		Double Shaft		CRK566BP-PS5	CRK566BP-PS7	CRK566BP-PS10	CRK564BP-PS25	CRK564BP-PS36	CRK564BP-PS50
Maximum Holding Torque			N·m	3.5	4	5	8		
Rotor Inertia			J: kg·m ²	280×10 ⁻⁷			175×10 ⁻⁷		
Rated Current			A/Phase	1.4					
Basic Step Angle				0.144°	0.1°	0.072°	0.0288°	0.02°	0.0144°
Gear Ratio				5	7.2	10	25	36	50
Permissible Torque			N·m	3.5	4	5	8		
Maximum Torque			N·m	7	9	11	16	20	
Holding Torque at Motor Standstill	Power ON	N·m		2	2.9	4.1	5.2	7.5	8
Backlash			arc minute (degrees)	15 (0.25°)					
Permissible Speed Range			r/min	0~600	0~416	0~300	0~120	0~83	0~60
Power Supply Voltage				24 VDC±10%			2.5 A		
Excitation Mode				Microstep					

*Certification for UL standards is only acquired on pulse input package.

Speed – Torque Characteristics

CRK566 Gear Ratio 5

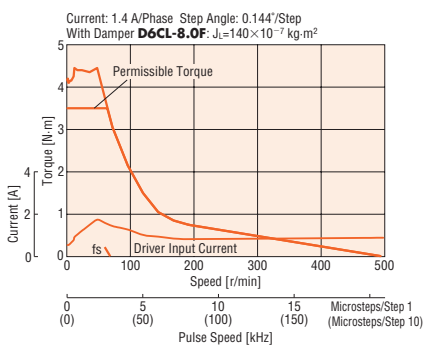

CRK566 Gear Ratio 7.2

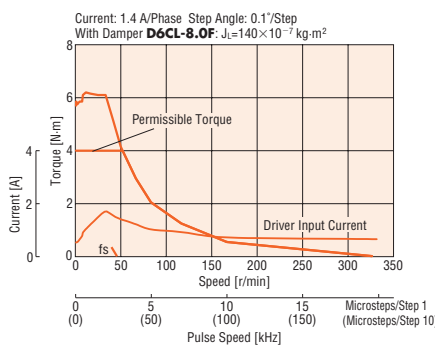

CRK566 Gear Ratio 10

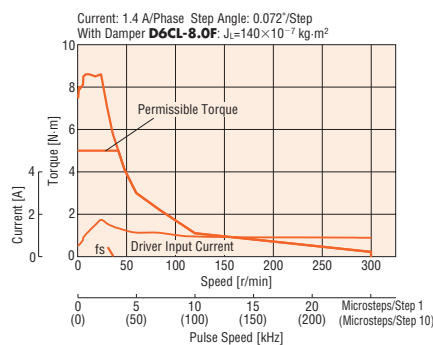

CRK564 Gear Ratio 25

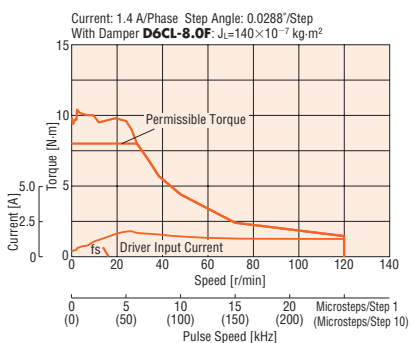

CRK564 Gear Ratio 36

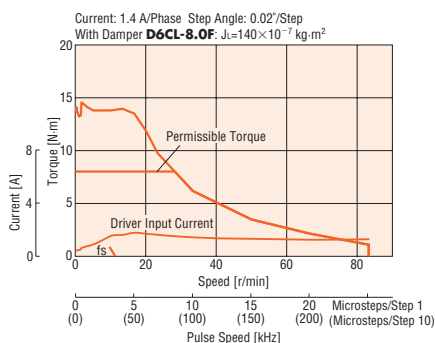

CRK564 Gear Ratio 50

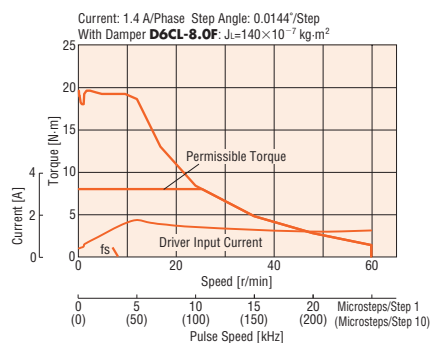

● The pulse input circuit responds to approximately 500 kHz with a pulse duty of 50%.

Note

- Depending on the driving conditions, a considerable amount of heat may be generated by the motor. Be sure to keep the motor case temperature at 100°C or less.
[When conforming to the UL or CSA Standards, it is required to keep the temperature of the motor case at 75°C or less, since the motor is recognized as thermal class 105 (A).]

PN Geared Type Frame Size 28 mm, 42 mm

Specifications RoHS



Product Name	Built-In Controller Package		Single Shaft	CRK523PAKD-N5*2	CRK523PAKD-N7.2*2	CRK523PAKD-N10*2	CRK544AKD-N5	CRK544AKD-N7.2	CRK544AKD-N10
	Pulse Input Package		Single Shaft	CRK523PAP-N5*2	CRK523PAP-N7.2*2	CRK523PAP-N10*2	CRK544AP-N5	CRK544AP-N7.2	CRK544AP-N10
		Double Shaft		CRK523PBK-N5*2	CRK523PBK-N7.2*2	CRK523PBK-N10*2	CRK544BK-N5	CRK544BK-N7.2	CRK544BK-N10
		Double Shaft		CRK523PBP-N5*2	CRK523PBP-N7.2*2	CRK523PBP-N10*2	CRK544BP-N5	CRK544BP-N7.2	CRK544BP-N10
Maximum Holding Torque			N-m	0.2	0.3	0.4	0.8	1.2	1.5
Rotor Inertia			J: kg·m ²	9×10 ⁻⁷			54×10 ⁻⁷		
Rated Current			A/Phase	0.35			0.75		
Basic Step Angle				0.144°	0.1°	0.072°	0.144°	0.1°	0.072°
Gear Ratio				5	7.2	10	5	7.2	10
Permissible Torque			N-m	0.2	0.3	0.4	0.8	1.2	1.5
Maximum Torque			N-m	0.5			1.5	2	
Holding Torque at Motor Standstill	Power ON	N-m		0.12	0.17	0.24	0.45	0.64	0.9
Backlash			arc minute (degrees)	3 (0.05°)			2 (0.034°)		
Permissible Speed Range			r/min	0~600	0~416	0~300	0~600	0~416	0~300
Power Supply Voltage				24 VDC±10% 0.7 A			24 VDC±10% 1.4 A		
Excitation Mode				Microstep					

*1 Certification for UL standards is only acquired on pulse input package.

*2 A connection cable (0.6 m) is included with the connector-coupled motor and driver package.

Speed – Torque Characteristics

CRK523 Gear Ratio 5

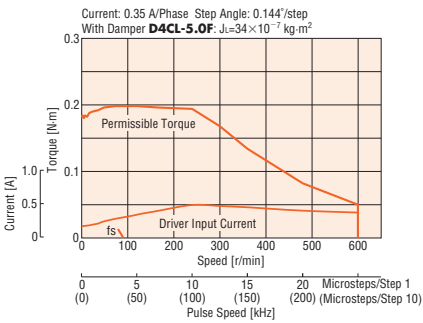

CRK523 Gear Ratio 7.2

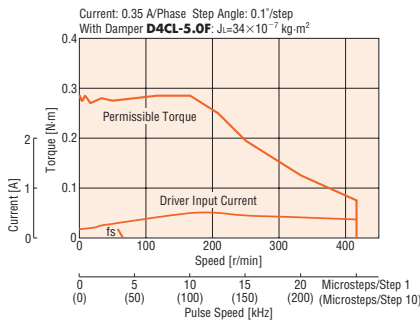

CRK523 Gear Ratio 10

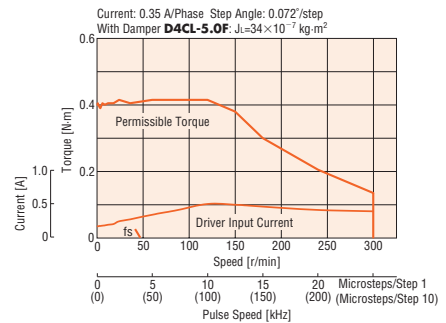

CRK544 Gear Ratio 5

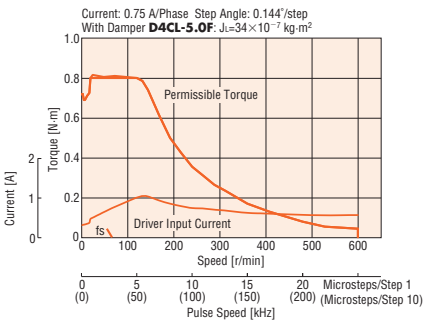

CRK544 Gear Ratio 7.2

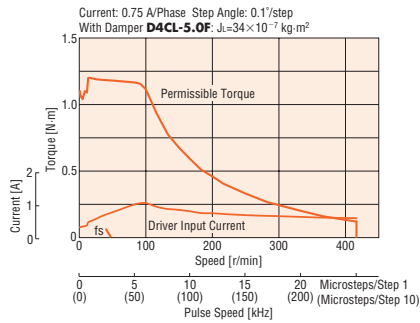

CRK544 Gear Ratio 10

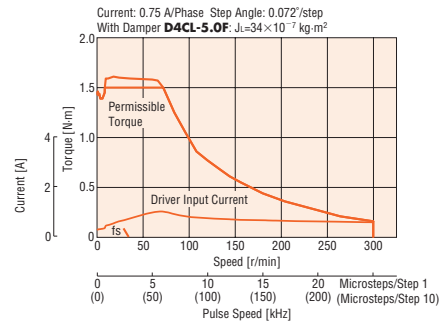

● The pulse input circuit responds to approximately 500 kHz with a pulse duty of 50%.

Note

● Depending on the driving conditions, a considerable amount of heat may be generated by the motor. Be sure to keep the motor case temperature at 100°C or less.
[When conforming to the UL or CSA Standards, it is required to keep the temperature of the motor case at 75°C or less, since the motor is recognized as thermal class 105 (A).]

PN Geared Type Frame Size 60 mm

Specifications RoHS



Product Name	Built-In Controller Package		CRK566AKD-N5	CRK566AKD-N7.2	CRK566AKD-N10	CRK564AKD-N25	CRK564AKD-N36	CRK564AKD-N50
	Single Shaft	Double Shaft	CRK566BKD-N5	CRK566BKD-N7.2	CRK566BKD-N10	CRK564BKD-N25	CRK564BKD-N36	CRK564BKD-N50
	Pulse Input Package		CRK566AP-N5	CRK566AP-N7.2	CRK566AP-N10	CRK564AP-N25	CRK564AP-N36	CRK564AP-N50
	Single Shaft	Double Shaft	CRK566BP-N5	CRK566BP-N7.2	CRK566BP-N10	CRK564BP-N25	CRK564BP-N36	CRK564BP-N50
Maximum Holding Torque	N·m		3.5	4	5	8		
Rotor Inertia	J: kg·m ²		280×10 ⁻⁷			175×10 ⁻⁷		
Rated Current	A/Phase		1.4					
Basic Step Angle			0.144°	0.1°	0.072°	0.0288°	0.02°	0.0144°
Gear Ratio			5	7.2	10	25	36	50
Permissible Torque	N·m		3.5	4	5	8		
Maximum Torque	N·m		7	9	11	16	20	
Holding Torque at Motor Standstill Power ON	N·m		2	2.9	4.1	5.2	7.5	8
Backlash	arc minute (degrees)		2 (0.034°)			3 (0.05°)		
Permissible Speed Range	r/min		0~600	0~416	0~300	0~120	0~83	0~60
Power Supply Voltage			24 VDC ±10%			2.5 A		
Excitation Mode			Microstep					

*Certification for UL standards is only acquired on pulse input package.

Speed – Torque Characteristics

CRK566 Gear Ratio 5

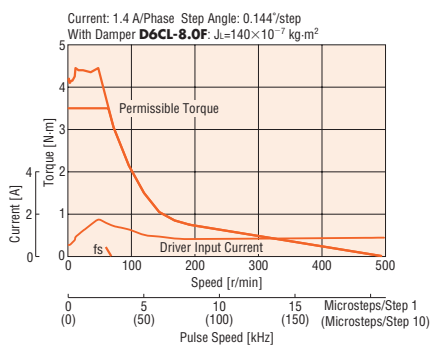

CRK566 Gear Ratio 7.2

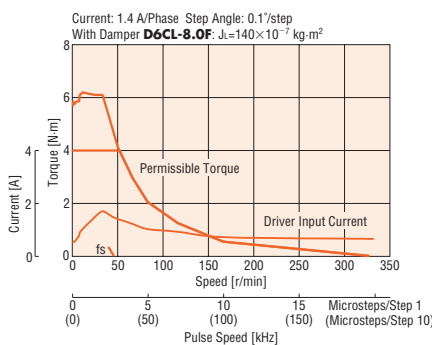

CRK566 Gear Ratio 10

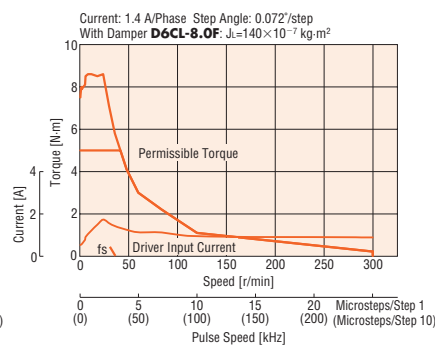

CRK564 Gear Ratio 25

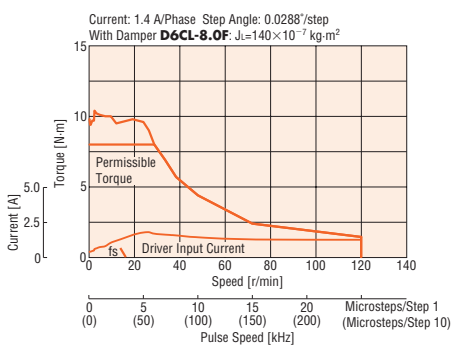

CRK564 Gear Ratio 36

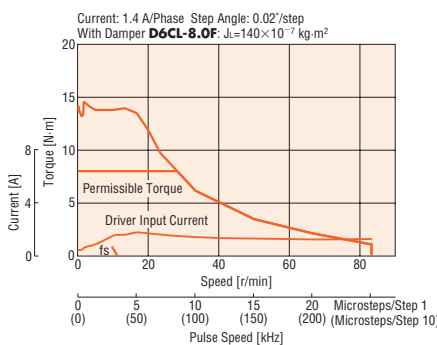

CRK564 Gear Ratio 50

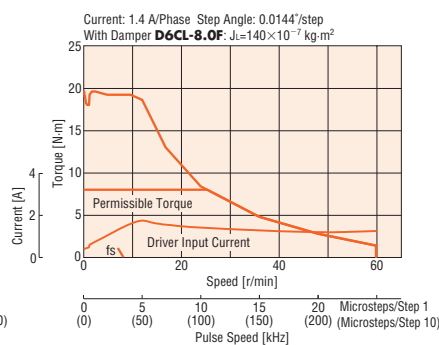

● The pulse input circuit responds to approximately 500 kHz with a pulse duty of 50%.

Note

- Depending on the driving conditions, a considerable amount of heat may be generated by the motor. Be sure to keep the motor case temperature at 100°C or less.
[When conforming to the UL or CSA Standards, it is required to keep the temperature of the motor case at 75°C or less, since the motor is recognized as thermal class 105 (A).]

Harmonic Geared Type Frame Size 20 mm, 30 mm

Specifications RoHS



Product Name	Built-In Controller Package		CRK513PAKD-H50	CRK513PAKD-H100	CRK523PAKD-H50	CRK523PAKD-H100
	Pulse Input Package	Single Shaft	CRK513PBKD-H50	CRK513PBKD-H100	CRK523PBKD-H50	CRK523PBKD-H100
		Double Shaft	CRK513PAP-H50	CRK513PAP-H100	CRK523PAP-H50	CRK523PAP-H100
		Double Shaft	CRK513PBP-H50	CRK513PBP-H100	CRK523PBP-H50	CRK523PBP-H100
Maximum Holding Torque		N·m	0.4	0.6	1.8	2.4
Rotor Inertia		J: kg·m ²	2.1×10 ⁻⁷		12×10 ⁻⁷	
Rated Current		A/Phase	0.35		0.75	
Basic Step Angle			0.0144°	0.0072°	0.0144°	0.0072°
Gear Ratio			50	100	50	100
Permissible Torque		N·m	0.4	0.6	1.8	2.4
Maximum Torque		N·m	0.9	1.4	3.3	4.8
Holding Torque at Motor Standstill Power ON		N·m	0.4	0.6	1.2	2.4
Lost Motion (Load Torque)		arc minute	2 max. (±0.02 N·m)	2 max. (±0.03 N·m)	1.5 max. (±0.09 N·m)	1.5 max. (±0.12 N·m)
Permissible Speed Range		r/min	0~90	0~45	0~70	0~35
Power Supply Voltage			24 VDC±10% 0.7 A		24 VDC±10% 1.4 A	
Excitation Mode			Microstep			

● A connection cable (0.6 m) is included with the connector-coupled motor and driver package.

Note

- The inertia represents a sum of the inertia of the harmonic gear converted to a motor shaft value, and the rotor inertia.
- * Certification for UL standards is only acquired on pulse input package.

Speed – Torque Characteristics

CRK513 Gear Ratio 50

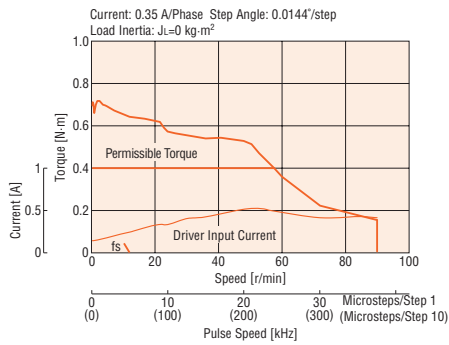

CRK513 Gear Ratio 100

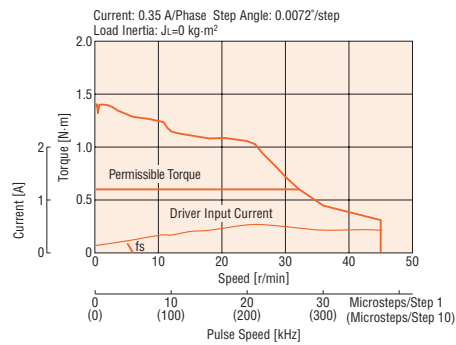

CRK523 Gear Ratio 50

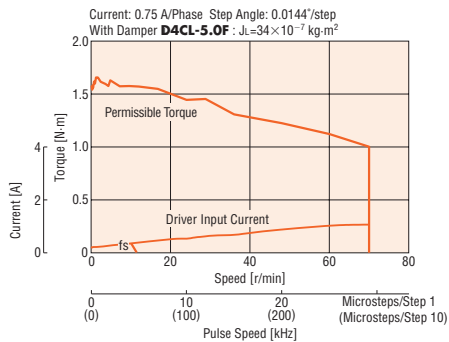

CRK523 Gear Ratio 100

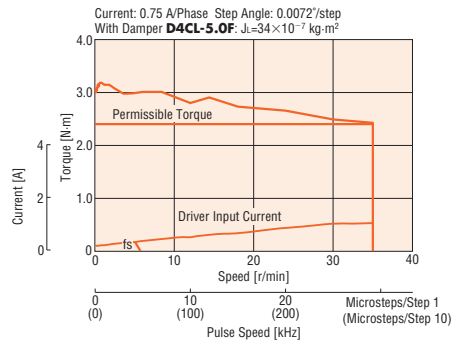

● The pulse input circuit responds to approximately 500 kHz with a pulse duty of 50%.

Note

- Depending on the driving conditions, a considerable amount of heat may be generated by the motor. Be sure to keep the motor case temperature at 100°C or less.
[When conforming to the UL or CSA Standards, it is required to keep the temperature of the motor case at 75°C or less, since the motor is recognized as thermal class 105 (A).]
- In order to prevent deterioration of the gear grease in the harmonic geared type, keep the temperature of the gear case at 70°C or less.

Harmonic Geared Type Frame Size 42 mm, 60 mm

Specifications RoHS



Product Name	Built-In Controller Package	Single Shaft	CRK543AKD-H50	CRK543AKD-H100	CRK564AKD-H50	CRK564AKD-H100
		Double Shaft	CRK543BKD-H50	CRK543BKD-H100	CRK564BKD-H50	CRK564BKD-H100
		Pulse Input Package	CRK543AP-H50	CRK543AP-H100	CRK564AP-H50	CRK564AP-H100
		Double Shaft	CRK543BP-H50	CRK543BP-H100	CRK564BP-H50	CRK564BP-H100
Maximum Holding Torque		N·m	3.5	5	5.5	8
Rotor Inertia		J: kg·m ²	52×10 ⁻⁷		210×10 ⁻⁷	
Rated Current		A/Phase	0.75		1.4	
Basic Step Angle			0.0144°	0.0072°	0.0144°	0.0072°
Gear Ratio			50	100	50	100
Permissible Torque		N·m	3.5	5	5.5	8
Maximum Torque		N·m	8.3	11	18	28
Holding Torque at Motor Standstill	Power ON	N·m	3.2	5	5.5	8
Lost Motion (Load Torque)		arc minute	1.5 max. (±0.16 N·m)	1.5 max. (±0.2 N·m)	0.7 max. (±0.28 N·m)	0.7 max. (±0.39 N·m)
Permissible Speed Range		r/min	0~70	0~35	0~70	0~35
Power Supply Voltage			24 VDC±10% 1.4 A		24 VDC±10% 2.5 A	
Excitation Mode			Microstep			

Note

- The inertia represents a sum of the inertia of the harmonic gear converted to a motor shaft value, and the rotor inertia.
- * Certification for UL standards is only acquired on pulse input package.

Speed – Torque Characteristics

CRK543 Gear Ratio 50

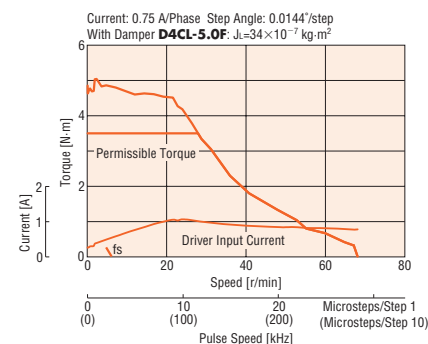

CRK543 Gear Ratio 100

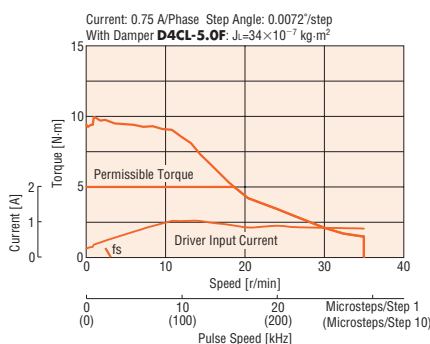

CRK564 Gear Ratio 50

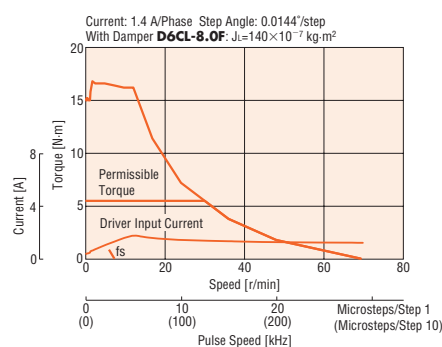

CRK564 Gear Ratio 100

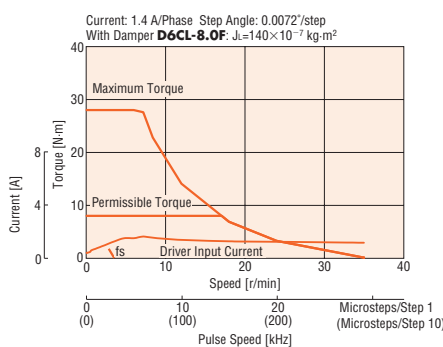

- The pulse input circuit responds to approximately 500 kHz with a pulse duty of 50%.

Note

- Depending on the driving conditions, a considerable amount of heat may be generated by the motor. Be sure to keep the motor case temperature at 100°C or less.
[When conforming to the UL or CSA Standards, it is required to keep the temperature of the motor case at 75°C or less, since the motor is recognized as thermal class 105 (A).]
- In order to prevent deterioration of the gear grease in the harmonic geared type, keep the temperature of the gear case at 70°C or less.

Common to Each Type

Driver Specifications

	Built-in Controller Package	Pulse Input Package
Maximum Input Pulse Frequency	–	500 kHz (When the pulse duty is 50%)
Number of Positioning Data Sets	63 Points	–
Positioning Operation	One-Shot	○
	Linked	○
	Linked 2	○
	Sequential	○
Continuous Operation	○	–
JOG Operation	○	–
Return-To-Home Operation	○	–
Test Operation	○	–
Control Module OPX-2A	○	–
Data Setting Software MEXE02	○	–

Built-In Controller Package RS-485 Communication Specifications

Protocol	Modbus protocol (Modbus RTU mode)
Electrical Characteristics	EIA-485 compliance Twisted-pair wire (TIA/EIA-568B CAT5e or greater recommended) is used up to a total extension length of 50 m.
Transmission/Reception Mode	Half-duplex communication
Baud Rate	9600 bps/19200 bps/38400 bps/57600 bps/115200 bps
Physical Layer	Asynchronous mode (data: 8-bit, stop bit: 1-bit/2-bit, parity: none/odd/even)
Connection Type	Up to 31 units can be connected to one programmable controller (master equipment).

General Specifications

	Motor	Driver	
		Built-In Controller Package	Pulse Input Package
Thermal Class	130 (B) [Recognized as class 105(A) by UL.]	–	
Insulation Resistance	The measured value is 100 MΩ or min. when a 500 VDC megger is applied between the windings and the case under normal ambient temperature and humidity.	100 MΩ or more when 500 VDC megger is applied between the following places: · FG terminal – Power supply terminal	–
Dielectric Strength	No abnormality is judged even with application of 1.5 kV* at 50 Hz or 60 Hz between the windings and the case for 1 minute under normal ambient temperature and humidity. *CRK54□: 1.0 kV CRK513P, CRK52□PM, CRK52□HPM, CRK52□P, CRK52□HP, CRK54□PM, CRK54□P : 0.5 kV	No abnormality is judged with the following application for 1 minute under normal ambient temperature and humidity: · FG terminal – Power supply terminal 500 AVC 50 Hz or 60 Hz	–
Operating Environment (In operation)	Ambient Temperature	–10~+50°C (non-freezing) : High-Resolution type, High-Torque type, Standard Type TH, PS and PN Geared Types 0~+40°C (non-freezing) : Harmonic Geared Type	
	Ambient Humidity	85% or less (non-condensing)	
	Atmosphere	No corrosive gases, dust, water or oil	
Temperature Rise	Temperature rise of windings is 80°C max. at rated current and 5-phases excitation, at standstill (resistance change method).	–	
Stop Position Accuracy*1	±3 arc minutes (±0.05°), CRK513P ±10 arc minutes (±0.17°) High-Resolution Type ±2 arc minutes (±0.034°)	–	
Shaft Runout	0.05 T. I. R. (mm)*4	–	
Radial Play*2	0.025 mm max. of 5 N	–	
Axial Play*3	0.075 mm max. of 10 N	–	
Concentricity for Shaft in the Mounting Pilot	0.075 T. I. R. (mm)*4	–	
Perpendicularity for Shaft of the Mounting Surface	0.075 T. I. R. (mm)*4	–	

*1 This value is for full step under no load. (The value changes with the size of the load.)

*2 Radial Play: Displacement in shaft position in the radial direction when 5 N load is applied in the vertical direction to the tip of the motor's shaft.

*3 Axial Play: Displacement in shaft position in the axial direction when a 10 N load is applied to the motor's shaft in the axial direction.

*4 T. I. R. (Total Indicator Reading): The total dial gauge reading when the measurement section is rotated one revolution centered on the reference axis shaft center.

Note

● Do not measure insulation resistance or perform the dielectric strength test while the motor and driver are connected.

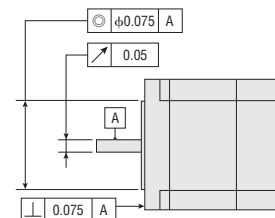

Encoder Specifications

● Frame Size 20 mm/28 mm

Resolution	500 P/R
Output Mode	Incremental
Output Signal	3 Channel
Voltage	5 VDC ± 10%
Current	50 mA
Output Circuit Type	Line Driver

● Frame Size 42 mm/60 mm

Resolution	500 P/R
Output Mode	Incremental
Output Signal	3 Channel
Voltage	5 VDC ± 5%
Current	Frame Size 42 mm: 160 mA Frame Size 60 mm: 140 mA
Output Circuit Type	Line Driver

Permissible Overhung Load and Permissible Thrust Load

→ Page A-14

Dimensions (Unit = mm)

● Motors

◇ High-Resolution Type, High-Torque Type

Frame Size 20 mm

Product Name		Motor Product Name	Mass kg
Built-In Controller Package	Pulse Input Package		
CRK513PAKD	CRK513PAP	PK513PA	0.05
CRK513PBKD	CRK513PBP	PK513PB	

A connection cable (0.6 m) is included with the motor and driver package.

UL Style 3265, AWG 24 (0.2 mm²)

If you are purchasing only a motor for maintenance purposes, etc., connection cable and connector will not be supplied.

Please provide separately. → Page A-352

● Applicable Connector

Connector Housing: 51065-0500 (Molex)

Contact: 50212-8100 (Molex)

Crimp Tool: 57176-5000 (Molex)

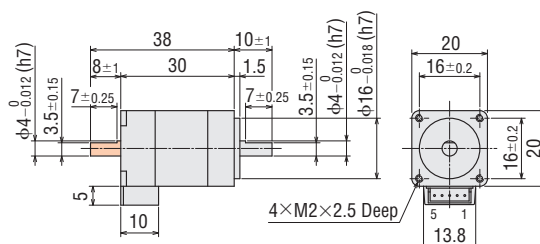

Frame Size 28 mm

Product Name		Motor Product Name	L1	L2	Mass kg
Built-In Controller Package	Pulse Input Package				
CRK523□P□AKD	CRK523□P□AP	PK523□P□A	32	—	0.11
CRK523□P□BKD	CRK523□P□BP	PK523□P□B		42	
CRK524□P□AKD	CRK524□P□MAP	PK524□P□MA	40	—	0.15
CRK524□P□BKD	CRK524□P□MBP	PK524□P□MB		50	
CRK525□P□AKD	CRK525□P□AP	PK525□P□A	51.5	—	0.2
CRK525□P□BKD	CRK525□P□BP	PK525□P□B		61.5	

A connection cable (0.6 m) is included with the motor and driver package.

UL Style 3265, AWG 24 (0.2 mm²)

If you are purchasing only a motor for maintenance purposes, etc., connection cable and connector will not be supplied.

Please provide separately. → Page A-352

● Applicable Connector

Connector Housing: 51065-0500 (Molex)

Contact: 50212-8100 (Molex)

Crimp Tool: 57176-5000 (Molex)

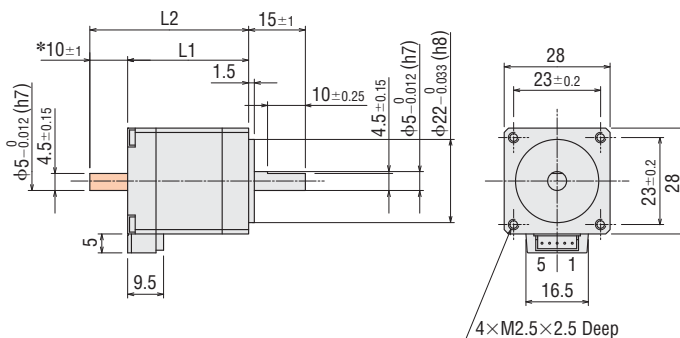

*The length of the shaft flat on the double shaft model is 10±0.25.

Frame Size 42 mm

Product Name		Motor Product Name	L1	L2	Mass kg
Built-In Controller Package	Pulse Input Package				
CRK544P□AKD	CRK544P□AP	PK544P□A	39	—	0.3
CRK544P□BKD	CRK544P□BP	PK544P□B		54	
CRK546P□AKD	CRK546P□AP	PK546P□A	59	—	0.5
CRK546P□BKD	CRK546P□BP	PK546P□B		74	

A connection cable (0.6 m) is included with the motor and driver package.

UL Style 3265, AWG 22 (0.3 mm²)

If you are purchasing only a motor for maintenance purposes, etc., connection cable and connector will not be supplied.

Please provide separately. → Page A-352

● Applicable Connector

Connector Housing: 51103-0500 (Molex)

Contact: 50351-8100 (Molex)

Crimp Tool: 57295-5000 (Molex)

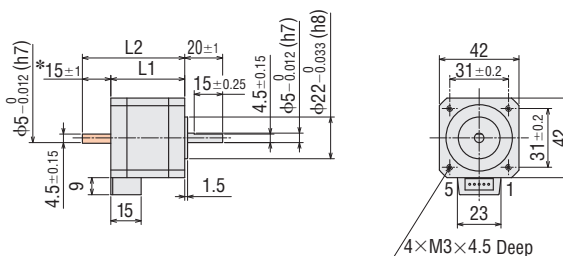

*The length of the shaft flat on the double shaft model is 15±0.25.

● For the high-speed specification, **H** is entered where the box □ is located within the product name.

For the high-resolution type, **M** is entered where the box □ is located within the product name.

● These dimensions are for double shaft models. For single shaft models, ignore the □ areas.

Frame Size 60 mm

Product Name		Motor Product Name	L1	L2	L3	φD	Mass kg
Built-In Controller Package	Pulse Input Package						
CRK564PMAKD	CRK564PMAP	PK564PMA	46.5	-	7.5±0.15	8 ⁰ _{-0.015}	0.65
CRK564PMBKD	CRK564PMBP	PK564PMB		69.5			
CRK566PMAKD	CRK566PMAP	PK566PMA	56	-	9.5±0.15	10 ⁰ _{-0.015}	0.87
CRK566PMBKD	CRK566PMBP	PK566PMB		79			
CRK569PMAKD	CRK569PMAP	PK569PMA	87	-	9.5±0.15	10 ⁰ _{-0.015}	1.5
CRK569PMBKD	CRK569PMBP	PK569PMB		110			

A connection cable (0.6 m) is included with the motor and driver package.
UL Style 3266, AWG 22 (0.3 mm²)
If you are purchasing only a motor for maintenance purposes, etc., connection cable and connector will not be supplied.
Please provide separately. → Page A-352

- Applicable Connector
Connector Housing: 51144-0500 (Molex)
Contact: 50539-8100 (Molex)
Crimp Tool: 57189-5000 (Molex)

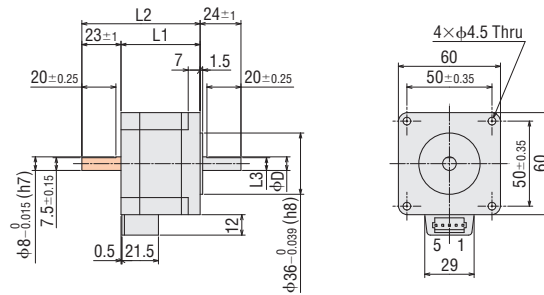

◇ High-Torque Type with Encoder

Frame Size 20 mm

Product Name	Motor Product Name	Mass kg
CRK513PRKD	PK513PA-R23L	0.05

A connection cable (0.6 m) is included with the motor and driver package.
UL Style 3265, AWG 22 (0.2 mm²)
If you are purchasing only a motor for maintenance purposes, etc., connection cable and connector will not be supplied.
Please provide separately. → Page A-352

- Applicable Connector
Connector Housing: 51065-0500 (Molex)
Contact: 50212-8100 (Molex)
Crimp Tool: 57176-5000 (Molex)

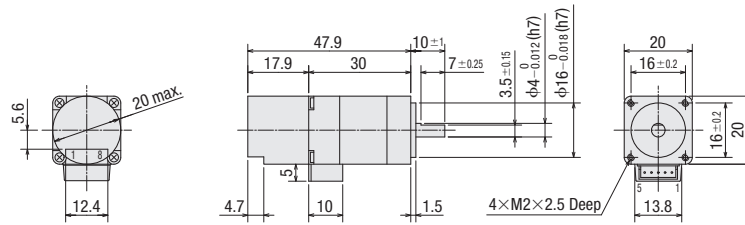

If you are purchasing a motor and driver package or only a motor, a connection cable for encoder (0.6 m) will be supplied.
UL Style 3265, AWG26 (0.14 mm²)

- Applicable Connector
Connector Housing: 51021-0800 (Molex)
Contact: 50079-8000 (Molex)
Crimp Tool: 63819-0300 (Molex)

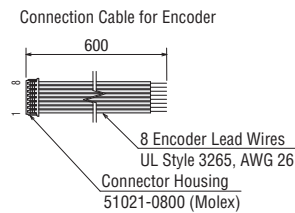

Frame Size 28 mm

Product Name	Motor Product Name	L	Mass kg
CRK523□PRKD	PK523□PA-R23L	51.9	0.11
CRK525□PRKD	PK525□PA-R23L	71.4	0.2

A connection cable (0.6 m) is included with the motor and driver package.
UL Style 3265, AWG 24 (0.2 mm²)
If you are purchasing only a motor for maintenance purposes, etc., connection cable and connector will not be supplied.
Please provide separately. → Page A-352

- Applicable Connector
Connector Housing: 51065-0500 (Molex)
Contact: 50212-8100 (Molex)
Crimp Tool: 57176-5000 (Molex)

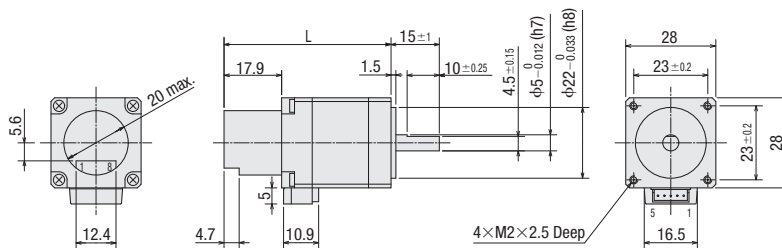

If you are purchasing a motor and driver package or only a motor, a connection cable for encoder (0.6 m) will be supplied.
UL Style 3265, AWG26 (0.14 mm²)

- Applicable Connector
Connector Housing: 51021-0800 (Molex)
Contact: 50079-8000 (Molex)
Crimp Tool: 63819-0300 (Molex)

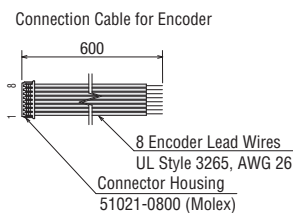

● For the high-speed specification, **H** is entered where the box □ is located within the product name.
● These dimensions are for double shaft models. For single shaft models, ignore the shaded areas.

Frame Size 42 mm

Product Name	Motor Product Name	L	Mass kg
Built-In Controller Package			
CRK544PRKD	PK544PA-R23L	61.5	0.36
CRK546PRKD	PK546PA-R23L	81.5	0.56

A connection cable (0.6 m) is included with the motor and driver package.

UL Style 3265, AWG 22 (0.3 mm²)

If you are purchasing only a motor for maintenance purposes, etc., connection cable and connector will not be supplied.

Please provide separately. → Page A-352

● Applicable Connector

Connector Housing: 51103-0500 (Molex)

Contact: 50351-8100 (Molex)

Crimp Tool: 57295-5000 (Molex)

◇ Standard Type

Frame Size 42 mm

Product Name	Motor Product Name	L1	L2	Mass kg
Built-In Controller Package				
CRK543AKD	PK543AW	33	-	0.25
CRK543BKD	PK543BW		48	
CRK544AKD	PK544AW	39	-	0.3
CRK544BKD	PK544BW		54	
CRK545AKD	PK545AW	47	-	0.4
CRK545BKD	PK545BW		62	

Frame Size 42 mm

Product Name	Motor Product Name	L1	L2	Mass kg
Pulse Input Package				
CRK543AP	PK543NAW	33	-	0.21
CRK543BP	PK543NBW		48	
CRK544AP	PK544NAW	39	-	0.27
CRK544BP	PK544NBW		54	
CRK545AP	PK545NAW	47	-	0.35
CRK545BP	PK545NBW		62	

Frame Size 60 mm

Product Name	Motor Product Name	L1	L2	Mass kg
Built-In Controller Package				
CRK564AKD	PK564AW	48.5	-	0.6
CRK564BKD	PK564BW		69.5	
CRK566AKD	PK566AW	59.5	-	0.8
CRK566BKD	PK566BW		80.5	
CRK569AKD	PK569AW	89	-	1.3
CRK569BKD	PK569BW		110	

Frame Size 60 mm

Product Name	Motor Product Name	L1	L2	Mass kg
Pulse Input Package				
CRK564AP	PK564NAW	46.5	-	0.6
CRK564BP	PK564NBW		69.5	
CRK566AP	PK566NAW	57.5	-	0.8
CRK566BP	PK566NBW		80.5	
CRK569AP	PK569NAW	87	-	1.3
CRK569BP	PK569NBW		110	

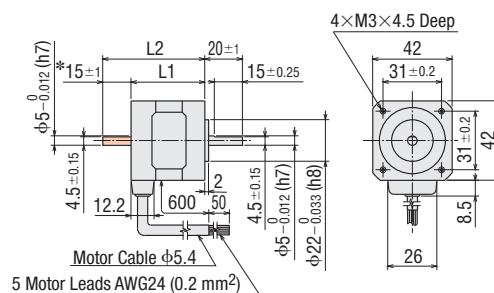
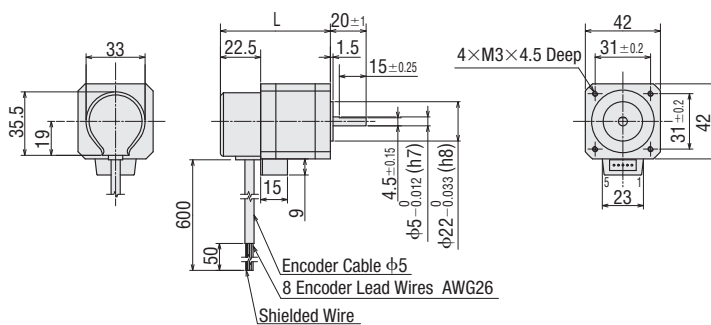

*The length of the shaft flat on the double shaft model is 15±0.25.

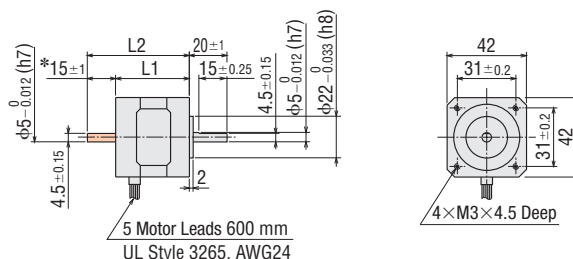

*The length of the shaft flat on the double shaft model is 15±0.25.

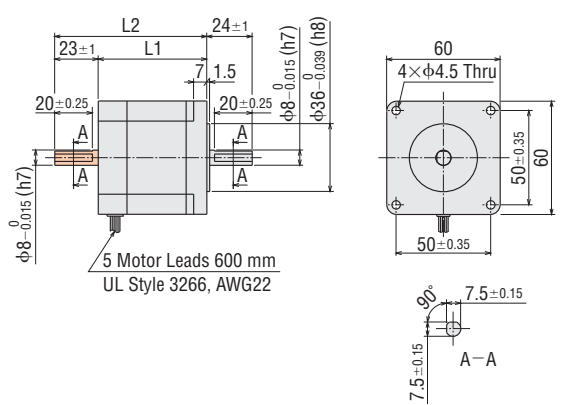
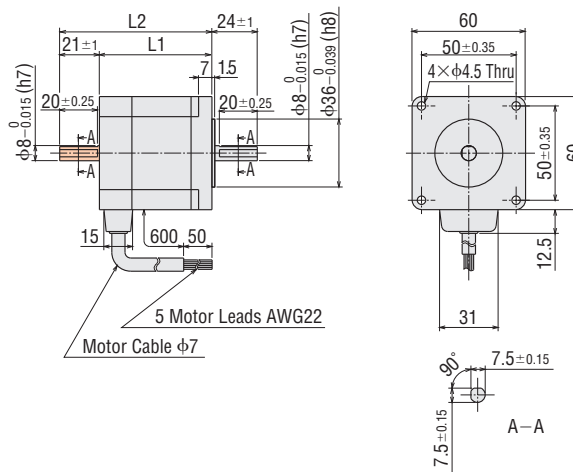

● These dimensions are for double shaft models. For single shaft models, ignore the  areas.

Introduction
0.36°/Geared
AR
AC Input Motor & Driver
0.72°/Geared
RK
0.36°/Geared
AR
0.36°/10.72°/
Geared
CRK
DC Input Motor & Driver
1.8°/Geared
RBK
0.9°/1.8°/Geared
CMK
0.72°
PK
1.8°/Geared
High-Torque
PKP
Motor Only
0.9°/1.8°/Geared
PK
Controllers
SG8030JY
Accessories

◇ Standard Type with Electromagnetic Brake

Frame Size 42 mm

Product Name	Motor Product Name	L	Mass kg
Built-In Controller Package			
CRK543AMKD	PK543AWM	63	0.37
CRK544AMKD	PK544AWM	69	0.42
CRK545AMKD	PK545AWM	77	0.52

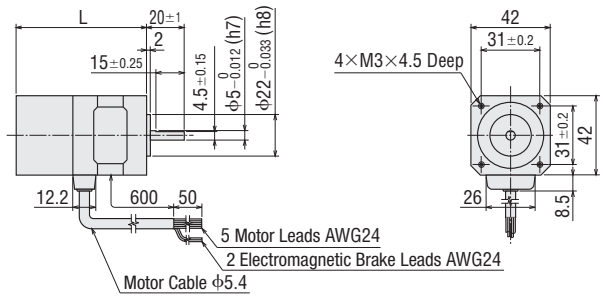

Frame Size 60 mm

Product Name	Motor Product Name	L	Mass kg
Built-In Controller Package			
CRK564AMKD	PK564AWM	88.5	0.9
CRK566AMKD	PK566AWM	99.5	1.1
CRK569AMKD	PK569AWM	129	1.6

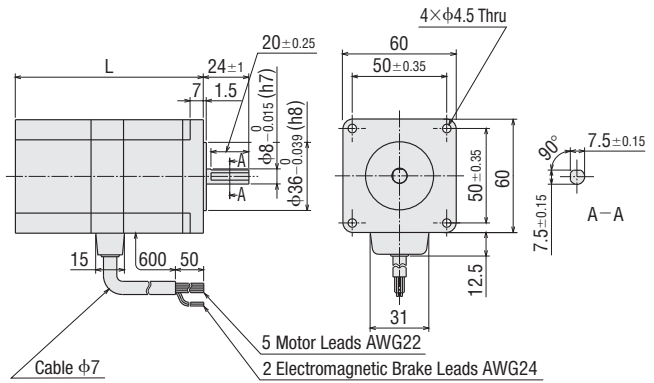

◇ Standard Type with Encoder

Frame Size 42 mm

Product Name	Motor Product Name	L	Mass kg
Built-In Controller Package			
CRK543RKD	PK543AW-R23L	55.5	0.31
CRK544RKD	PK544AW-R23L	61.5	0.36
CRK545RKD	PK545AW-R23L	69.5	0.46

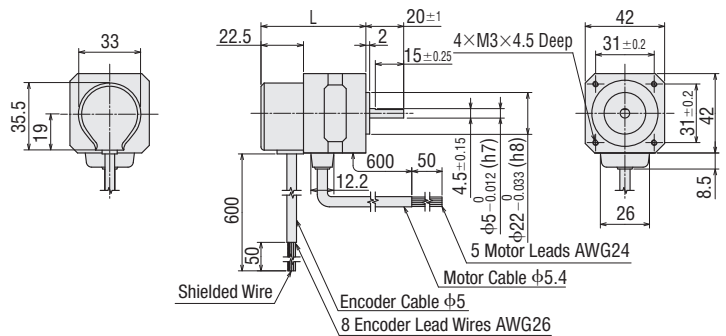

Frame Size 60 mm

Product Name	Motor Product Name	L	Mass kg
Built-In Controller Package			
CRK564RKD	PK564AW-R23L	73.5	0.7
CRK566RKD	PK566AW-R23L	84.5	0.9
CRK569RKD	PK569AW-R23L	114	1.4

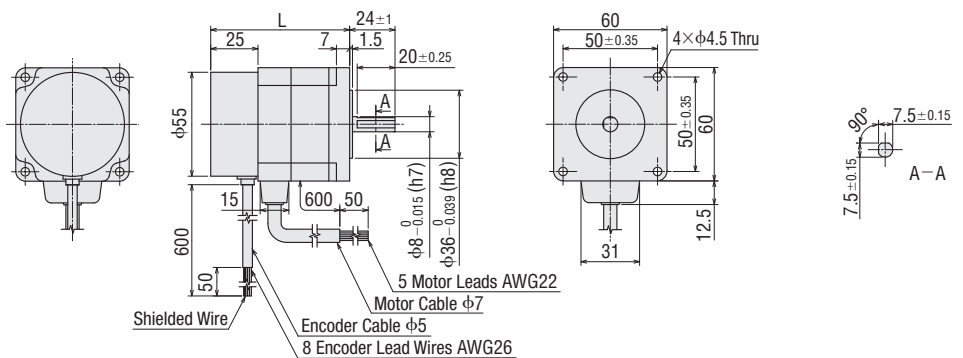

◇ TH Geared Type

Frame Size 28 mm

Product Name		Motor Product Name	Gear Ratio	Mass kg
Built-In Controller Package	Pulse Input Package			
CRK523PAKD-T	CRK523PAP-T	PK523PA-T	7.2, 10, 20, 30	0.17
CRK523PBKD-T	CRK523PBP-T	PK523PB-T		

A connection cable (0.6 m) is included with the motor and driver package.

UL Style 3265, AWG 24 (0.2 mm²)

If you are purchasing only a motor for maintenance purposes, etc., connection cable and connector will not be supplied.

Please provide separately. → Page A-352

● Applicable Connector

Connector Housing: 51065-0500 (Molex)

Contact: 50212-8100 (Molex)

Crimp Tool: 57176-5000 (Molex)

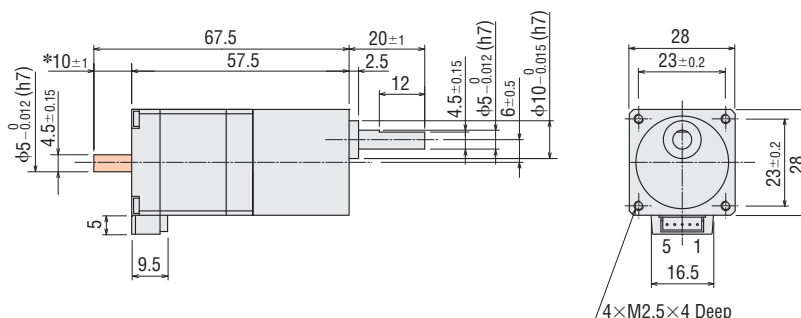

*The length of the shaft flat on the double shaft model is 10±0.25.

Frame Size 42 mm

Product Name		Motor Product Name	Gear Ratio	Mass kg
Built-In Controller Package	Pulse Input Package			
CRK543AKD-T	CRK543AP-T	PK543AW-T	3.6, 7.2, 10, 20, 30	0.35
CRK543BKD-T	CRK543BP-T	PK543BW-T		

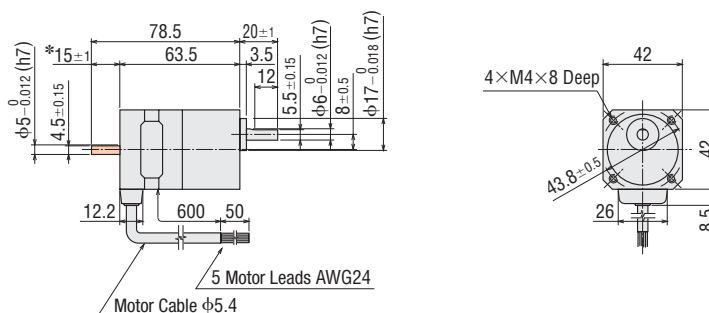

*The length of the shaft flat on the double shaft model is 15±0.25.

Frame Size 60 mm

Product Name		Motor Product Name	Gear Ratio	Mass kg
Built-In Controller Package	Pulse Input Package			
CRK564AKD-T	CRK564AP-T	PK564AW-T	3.6, 7.2, 10, 20, 30	0.95
CRK564BKD-T	CRK564BP-T	PK564BW-T		

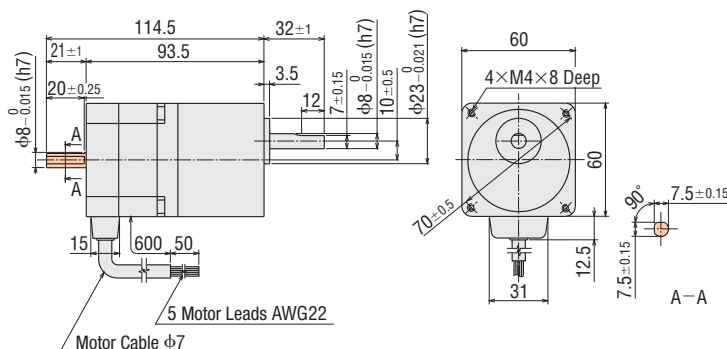

- A number indicating the gear ratio is entered where the box is located within the product name.
- These dimensions are for double shaft models. For single shaft models, ignore the areas.

◇ PS Geared Type

Frame Size 28 mm

Product Name		Motor Product Name	Gear Ratio	Mass kg
Built-In Controller Package	Pulse Input Package			
CRK523PAKD-PS	CRK523PAP-PS	PK523PA-PS	5, 7.2, 10	0.22
CRK523PBKD-PS	CRK523PBP-PS	PK523PB-PS		

A connection cable (0.6 m) is included with the motor and driver package.
UL Style 3265, AWG 24 (0.2 mm²)

If you are purchasing only a motor for maintenance purposes, etc.,
connection cable and connector will not be supplied.

Please provide separately. → Page A-352

● Applicable Connector

Connector Housing: 51065-0500 (Molex)

Contact: 50212-8100 (Molex)

Crimp Tool: 57176-5000 (Molex)

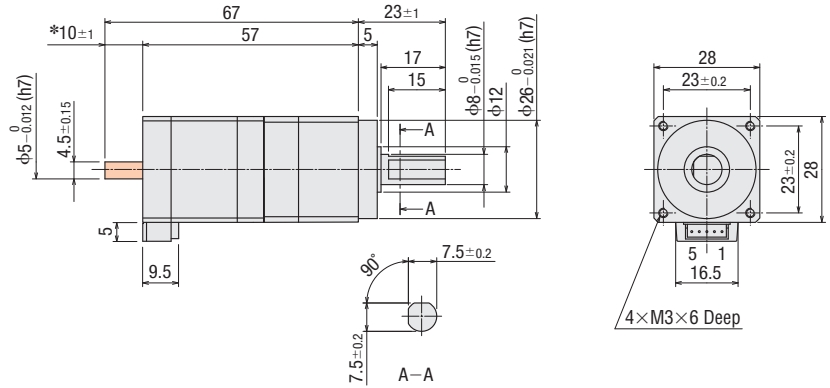

*The length of the shaft flat on the double shaft model is 10±0.25.

Frame Size 42 mm

Product Name		Motor Product Name	Gear Ratio	L1	L2	Mass kg
Built-In Controller Package	Pulse Input Package					
CRK545AKD-PS	CRK545AP-PS	PK545AW-PS	5, 7.2, 10	74.5	—	0.58
CRK545BKD-PS	CRK545BP-PS	PK545BW-PS			89.5	
CRK543AKD-PS	CRK543AP-PS	PK543AW-PS	25, 36, 50	84	—	0.59
CRK543BKD-PS	CRK543BP-PS	PK543BW-PS			99	

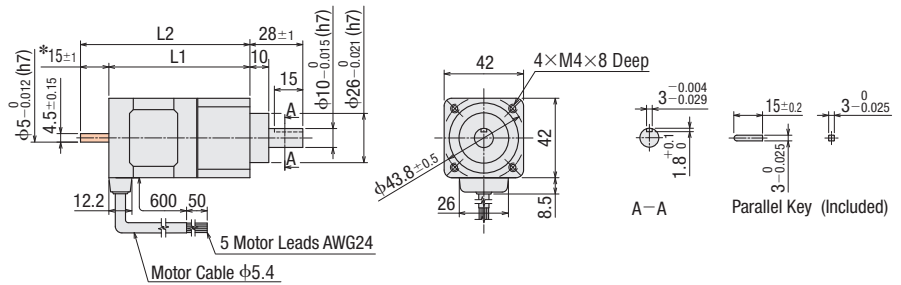

*The length of the shaft flat on the double shaft model is 15±0.25.

Frame Size 60 mm

Product Name		Motor Product Name	Gear Ratio	L1	L2	Mass kg
Built-In Controller Package	Pulse Input Package					
CRK566AKD-PS	CRK566AP-PS	PK566AW-PS	5, 7.2, 10	91.5	—	1.3
CRK566BKD-PS	CRK566BP-PS	PK566BW-PS			112.5	
CRK564AKD-PS	CRK564AP-PS	PK564AW-PS	25, 36, 50	101	—	1.4
CRK564BKD-PS	CRK564BP-PS	PK564BW-PS			122	

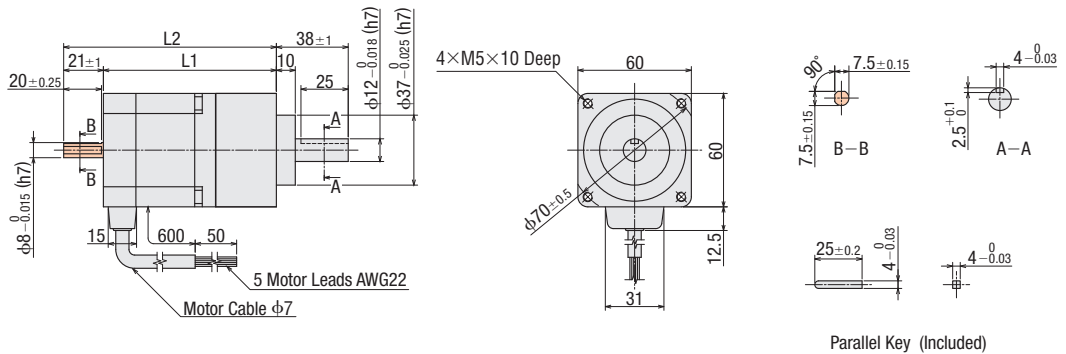

● A number indicating the gear ratio is entered where the box is located within the product name.
● These dimensions are for double shaft models. For single shaft models, ignore the areas.

◆ PN Geared Type

Frame Size 28 mm

Product Name		Motor Product Name	Gear Ratio	Mass kg
Built-In Controller Package	Pulse Input Package			
CRK523PAKD-N <input type="checkbox"/>	CRK523PAP-N <input type="checkbox"/>	PK523PA-N <input type="checkbox"/>	5, 7.2, 10	0.25
CRK523PBKD-N <input type="checkbox"/>	CRK523PBP-N <input type="checkbox"/>	PK523PB-N <input type="checkbox"/>		

A connection cable (0.6 m) is included with the motor and driver package.

UL Style 3265, AWG 24 (0.2 mm²)

If you are purchasing only a motor for maintenance purposes, etc., connection cable and connector will not be supplied.

Please provide separately. → Page A-352

●Applicable Connector

Connector Housing: 51065-0500 (Molex)

Contact: 50212-8100 (Molex)

Crimp Tool: 57176-5000 (Molex)

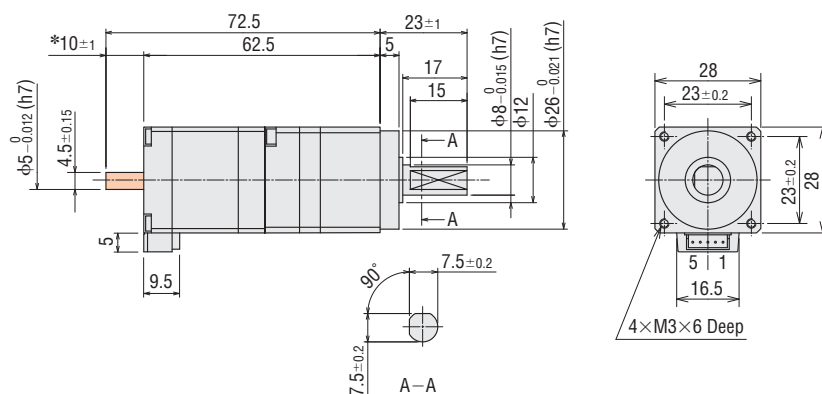

*The length of the shaft flat on the double shaft model is 10±0.25.

Frame Size 42 mm

Product Name		Motor Product Name	Gear Ratio	Mass kg
Built-In Controller Package	Pulse Input Package			
CRK544AKD-N <input type="checkbox"/>	CRK544AP-N <input type="checkbox"/>	PK544AW-N <input type="checkbox"/>	5, 7.2, 10	0.56
CRK544BKD-N <input type="checkbox"/>	CRK544BP-N <input type="checkbox"/>	PK544BW-N <input type="checkbox"/>		

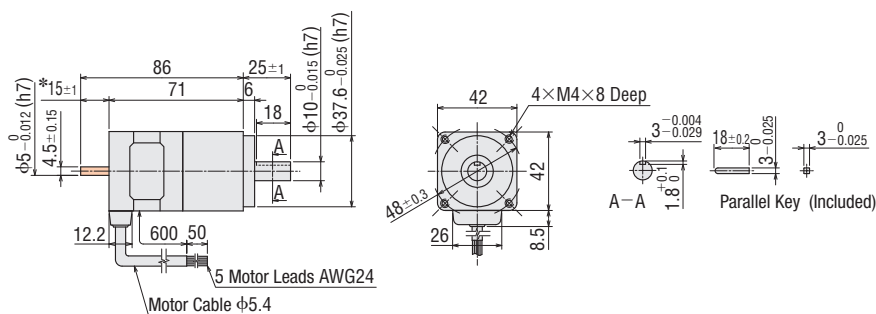

*The length of the shaft flat on the double shaft model is 15±0.25.

Frame Size 60 mm

Product Name		Motor Product Name	Gear Ratio	L1	L2	Mass kg
Built-In Controller Package	Pulse Input Package					
CRK566AKD-N <input type="checkbox"/>	CRK566AP-N <input type="checkbox"/>	PK566AW-N <input type="checkbox"/>	5, 7.2, 10	103.5	-	1.5
CRK566BKD-N <input type="checkbox"/>	CRK566BP-N <input type="checkbox"/>	PK566BW-N <input type="checkbox"/>				
CRK564AKD-N <input type="checkbox"/>	CRK564AP-N <input type="checkbox"/>	PK564AW-N <input type="checkbox"/>	25, 36, 50	108.5	-	1.5
CRK564BKD-N <input type="checkbox"/>	CRK564BP-N <input type="checkbox"/>	PK564BW-N <input type="checkbox"/>				

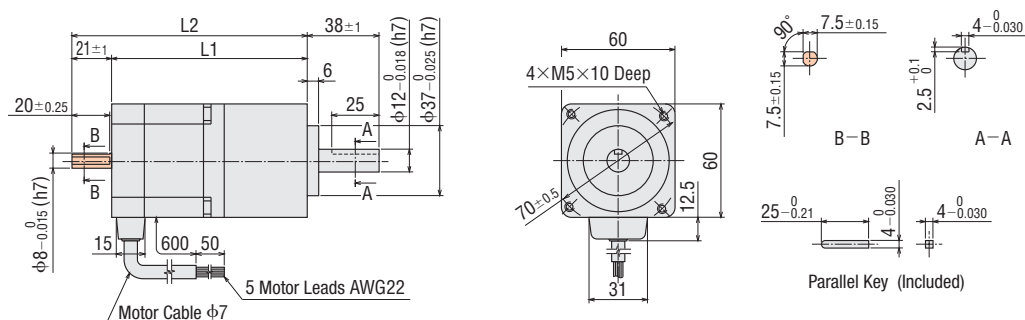

- A number indicating the gear ratio is entered where the box is located within the product name.
- These dimensions are for double shaft models. For single shaft models, ignore the areas.

◇ Harmonic Geared Type

Frame Size 20 mm

Product Name		Motor Product Name	Gear Ratio	Mass kg
Built-In Controller Package	Pulse Input Package			
CRK513PAKD-H	CRK513PAP-H	PK513PA-H	50, 100	0.08
CRK513PBKD-H	CRK513PBP-H	PK513PB-H		

A connection cable (0.6 m) is included with the motor and driver package.

UL Style 3265, AWG 24 (0.2 mm²)

If you are purchasing only a motor for maintenance purposes, etc., connection cable and connector will not be supplied.

Please provide separately. → Page A-352

● Applicable Connector

Connector Housing: 51065-0500 (Molex)

Contact: 50212-8100 (Molex)

Crimp Tool: 57176-5000 (Molex)

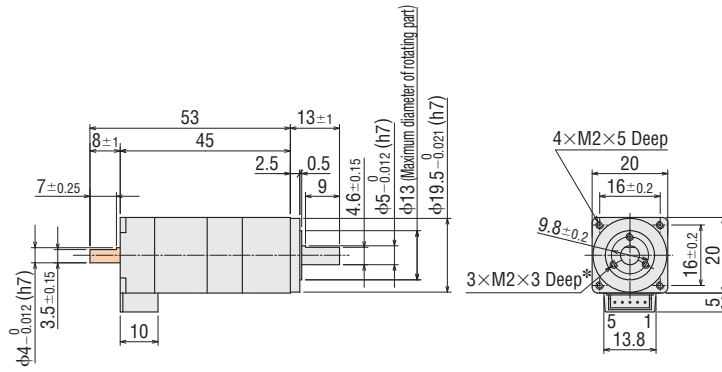

*The position of the output shaft relative to the screw holes on the rotating part is arbitrary.

Frame Size 30 mm

Product Name		Motor Product Name	Gear Ratio	Mass kg
Built-In Controller Package	Pulse Input Package			
CRK523PAKD-H	CRK523PAP-H	PK523HPA-H	50, 100	0.2
CRK523PBKD-H	CRK523PBP-H	PK523HPB-H		

A connection cable (0.6 m) is included with the motor and driver package.

UL Style 3265, AWG 24 (0.2 mm²)

If you are purchasing only a motor for maintenance purposes, etc., connection cable and connector will not be supplied.

Please provide separately. → Page A-352

● Applicable Connector

Connector Housing: 51065-0500 (Molex)

Contact: 50212-8100 (Molex)

Crimp Tool: 57176-5000 (Molex)

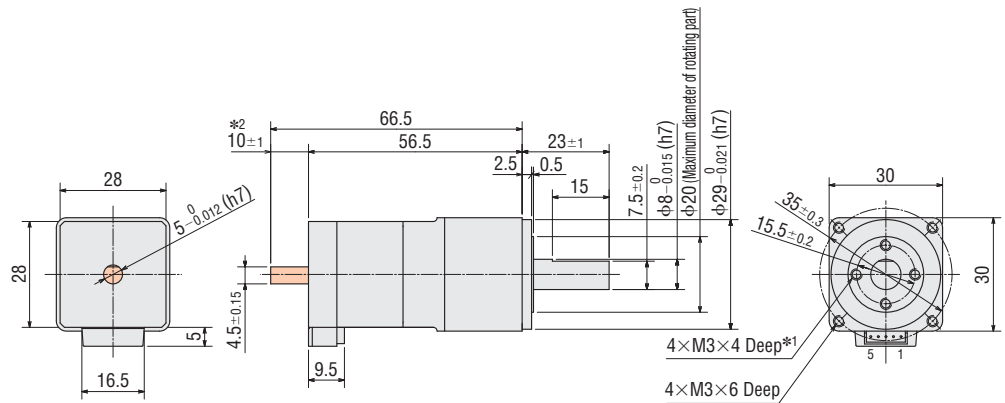

*1 The position of the output shaft relative to the screw holes on the rotating part is arbitrary.

*2 The length of the shaft flat on the double shaft model is 10±0.25.

Frame Size 42 mm

Product Name		Motor Product Name	Gear Ratio	Mass kg
Built-In Controller Package	Pulse Input Package			
CRK543AKD-H	CRK543AP-H	PK543AW-H	50, 100	0.46
CRK543BKD-H	CRK543BP-H	PK543BW-H		

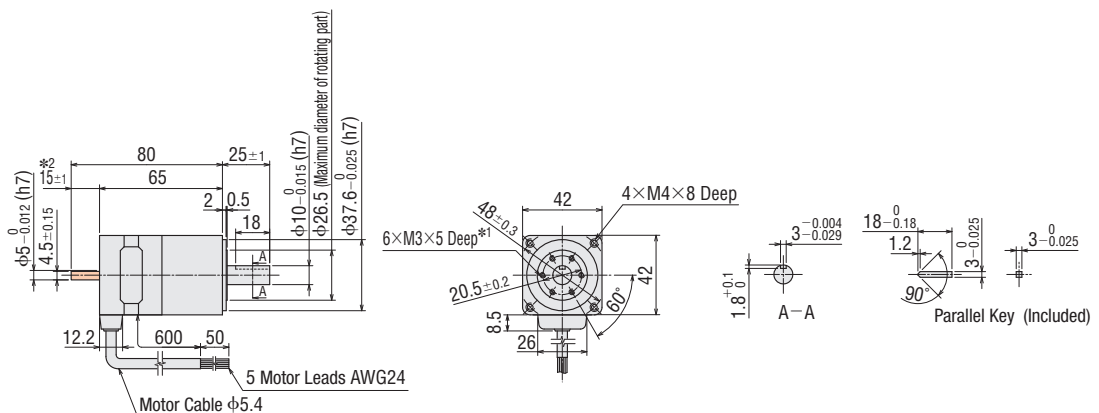

*1 The position of the output shaft relative to the screw holes on the rotating part is arbitrary.

*2 The length of the shaft flat on the double shaft model is 15±0.25.

● A number indicating the gear ratio is entered where the box is located within the product name.

● These dimensions are for double shaft models. For single shaft models, ignore the areas.

Frame Size 60 mm

Product Name		Motor Product Name	Gear Ratio	Mass kg
Built-In Controller Package	Pulse Input Package			
CRK564AKD-H 	CRK564AP-H 	PK564AW-H S	50, 100	1.08
CRK564BKD-H 	CRK564BP-H 	PK564BW-H S		

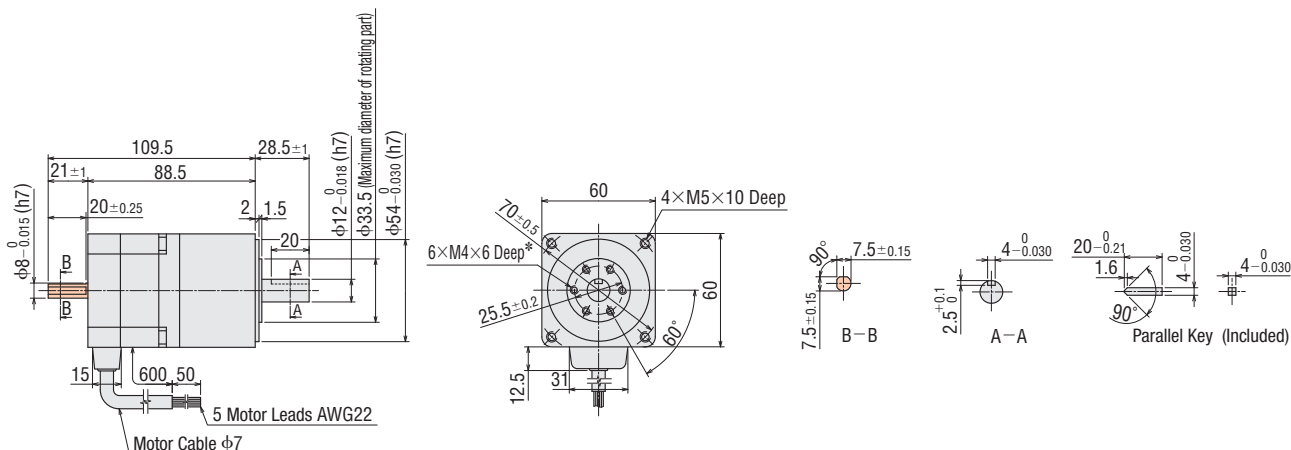

*The position of the output shaft relative to the screw holes on the rotating part is arbitrary.

- A number indicating the gear ratio is entered where the box is located within the product name.
- These dimensions are for double shaft models. For single shaft models, ignore the areas.

● Drivers

◇ Built-In Controller Package

Mass: 0.2 kg

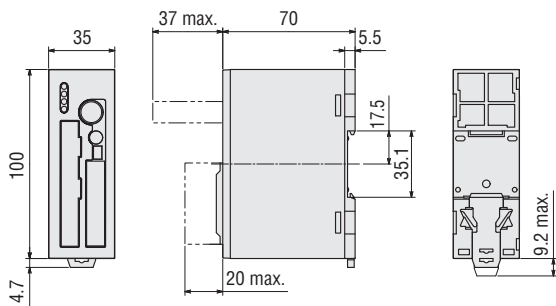

● Accessories

- Power Input Terminal (CN1)
Connector: MC1,5/3-STF-3,5 (PHOENIX CONTACT GmbH & Co. KG)
 - Connection Cable for I/O Connector (CN2):
Connector: FX2B-40SA-1.27R (HIROSE ELECTRIC CO., LTD)
 - Connection Cable for Motor (CN4):
Connector Housing: 51103-0500 (Molex)
Contact: 50351-8100 (Molex)
Applicable Crimp Tool: 57295-5000 (Molex)
 - Connection Cable for Encoder (CN5)*
Connector Housing: 51106-0900 (Molex)
Contact: 50351-8000 (Molex)
Applicable Crimp Tool: 57295-5000 (Molex)
- *Included with encoder motor only

- When you purchase only drivers for maintenance etc., it comes with power input terminal, connection cable for I/O connector and connection cable for motor.

● Connection Cable for I/O Connector (CN2)

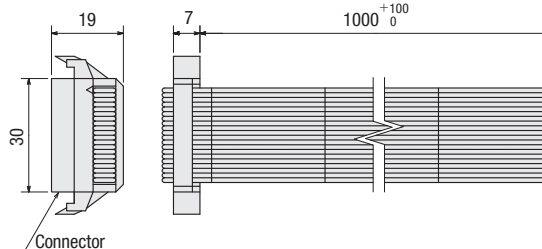

● Connection Cable for Motor (CN4)

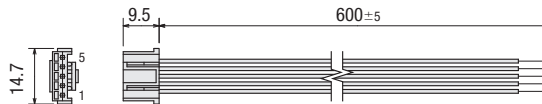

● Connection Cable for Encoder (CN5)

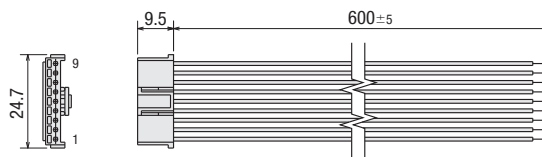

◇ Pulse Input Package

Mass: 0.04 kg

4× ϕ 3.5 Thru

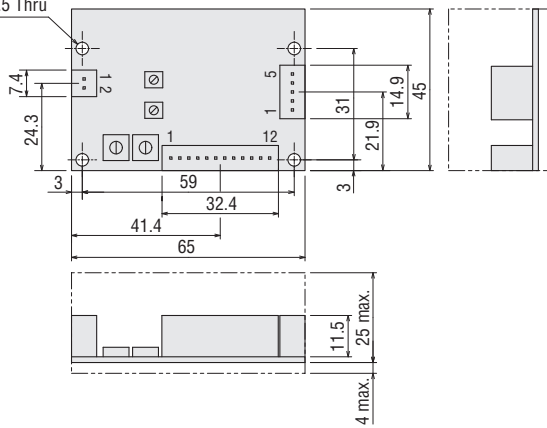

● Accessories

- Connector Housing: 51103-0200 (Molex)
- 51103-1200 (Molex)
- 51103-0500 (Molex)
- Contact : 50351-8100 (Molex)

Note

- Use the included connectors for the power supply, signal and motor. When assembling the connectors, use the hand crimp tool 57295-5000 (Molex). The crimp tool is not included. Please provide separately.
- The driver cable set (sold separately) crimped with connector is available as an accessory.
- Connection cable sets → Page A-353

Connection and Operation (Built-In Controller Package)

Names and Functions of Driver Parts

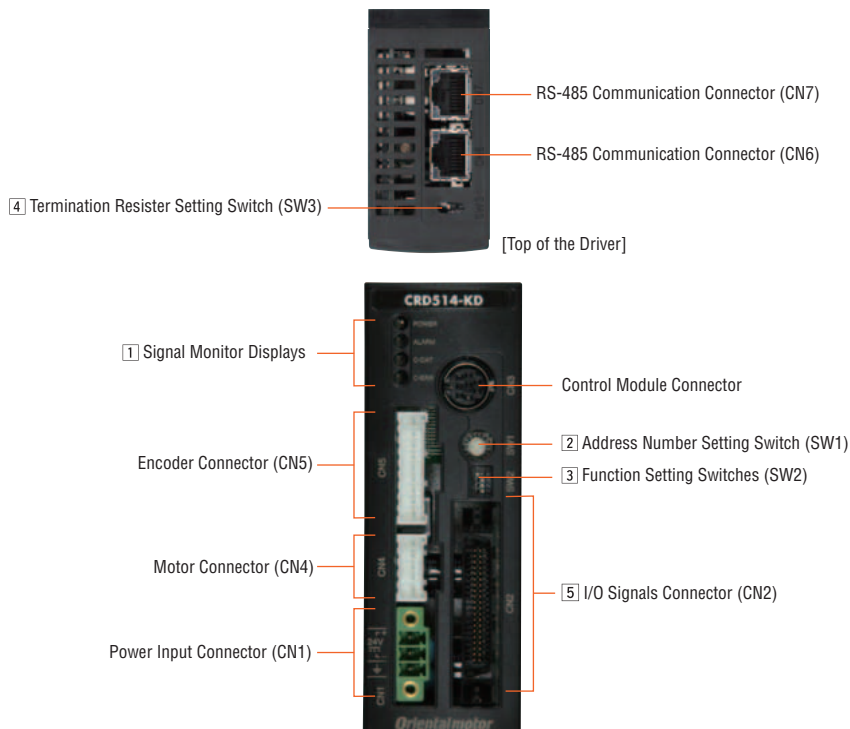

1 Signal Monitor Displays

◇ LED Indicators

Indication	Color	Function	When Activated
POWER	Green	Power Supply Indication	Lights when power is on.
ALARM	Red	Alarm Indication	Blinks when protective functions are activated.
C-DAT	Green	Communication Indication	Blinks or illuminate when communication data is received or sent.
C-ERR	Red	Communication Error Indication	Illuminates when there is an error with communication data.

◇ Alarm

Blink Count	Function	When Activated
2	Overheat	The internal temperature of the driver has reached approximately 85°C.
3	Overvoltage	The primary voltage of the driver's inverter has exceeded the allowable level.
4	Over Position Error*	The deviation between the encoder counter value and command position reached the step out detection band when the "step out detection action" parameter was set to "alarm".
7	±LS Both Sides Active	Both the +LS and -LS signals were detected when LS detection was enabled.
	Reverse ±LS Connection	The LS opposite to the operating direction has detected during a return-to-home operation.
	Home Seeking Error	Return-to-home operation did not complete normally.
	No HOMES	The HOMES is not detected at a position between +LS and -LS during return-to-home operation in 3-sensor mode.
	TIM, Index, SLIT Input Error	None of the SLIT input, TIM output and Index output could be detected during return-to home operation.
	Hardware Over Travel	A +LS or -LS signal was detected when hardware over travel was enabled.
	Software Over Travel	A software limit was reached when software over travel was enabled.
	Home Seeking Offset Error	A limit sensor signal was detected during offset movement as part of return-to-home operation.
	Invalid Operation Data	<ul style="list-style-type: none"> Five or more motions may be linked. Motion of different directions may be linked.
9	RS-485 Communication Error	The number of consecutive RS-485 communication errors reached the set value.
	RS-485 Communication Timeout	An RS-485 communication timeout was detected
9	EEPROM Error	The stored data was damaged.

*Appropriate encoder has to be used with your motor

2 Address Number Setting Switch (SW1)

Indication	Switch Name	Function
SW1	Address Number Setting Switch	Set the address number for RS-485 communication (Factory Setting: 0).

3 Function Setting Switches (SW2)

Indication	No.	Function
SW2	1	Set the baud rate for RS-485 communications. (Factory Setting: ON)
	2	
	3	
	4	Set device to signal or multi-axis mode. (Factory Setting: OFF)

◇ Setting the Baud Rate for RS-485 Communications

Baud Rate No.	9600 bps	19200 bps	38400 bps	57600 bps	115200 bps	250000 bps	312500 bps	625000 bps
1	OFF	ON	OFF	ON	OFF	ON	OFF	ON
2	OFF	OFF	ON	ON	OFF	OFF	ON	ON
3	OFF	OFF	OFF	OFF	ON	ON	ON	ON

◇ Setting the Multi-Axis Function for RS-485 Communications

No.	—	General-Purpose Master Device
4	OFF	ON

4 Termination Resister Setting Switch (SW3)

Indication	Switch Name	Function
SW3	Termination Resister Setting Switches	Set the termination resister (120 Ω) for RS-485 communication. OFF: No termination resister ON: Set the termination resister

5 I/O Signals Connector (CN2: 40 Pins)

Indication	Input/Output	Pin No.	Code	Signal Name
CN2	Input	A1	IN-COM0	Input Common
		A2	START	Start Input
		A3	ALM-RST	Alarm Reset Input
		A4	AWO	All Windings Off Input
		A5	STOP	Stop Input
		A6	M0	Data Selection Input
		A7	M1	
		A8	M2	
		A9	M3	
		A10	M4	
		A11	M5	
		A12	HOME/P-PRESET	Return-To-Home/Position Preset Input
		A13	FWD	Forward Input
		A14	RVS	Reverse Input
		A15	+LS	+Side Limit Sensor Input
		A16	-LS	-Side Limit Sensor Input
		A17	HOMES	Mechanical Home Sensor Input
		A18	SLIT	Slit Sensor Input
		A19	—	—
	A20	IN-COM1	Sensor Input Common	
Output	B1	MOVE+	Motor Moving Output	
	B2	MOVE-		
	B3	ALM+	Alarm Output	
	B4	ALM-		
	B5	OUT1+	Control Output 1*	
	B6	OUT1-		
	B7	OUT2+	Control Output 2*	
	B8	OUT2-		
	B9	OUT3+	Control Output 3*	
	B10	OUT3-		
	B11	OUT4+	Control Output 4*	
B12	OUT4-			
B13	—	—		
B14	—	—		
B15	PLS-OUT+	Pulse Output (Line Driver Output)		
B16	PLS-OUT-			
B17	DIR-OUT+	Rotation Direction Output (Line Driver Output)		
B18	DIR-OUT-			
B19	GND	GND		
B20	—	—		

*Control outputs 1 (OUT1) ~ 4 (OUT4) set the assigned functions by means of parameters.
The initial values are OUT1 (AREA), OUT2 (READY), OUT3 (WNG), and OUT4 (HOME-P).

● Connection Diagram

◇ Connection to Peripheral Equipment

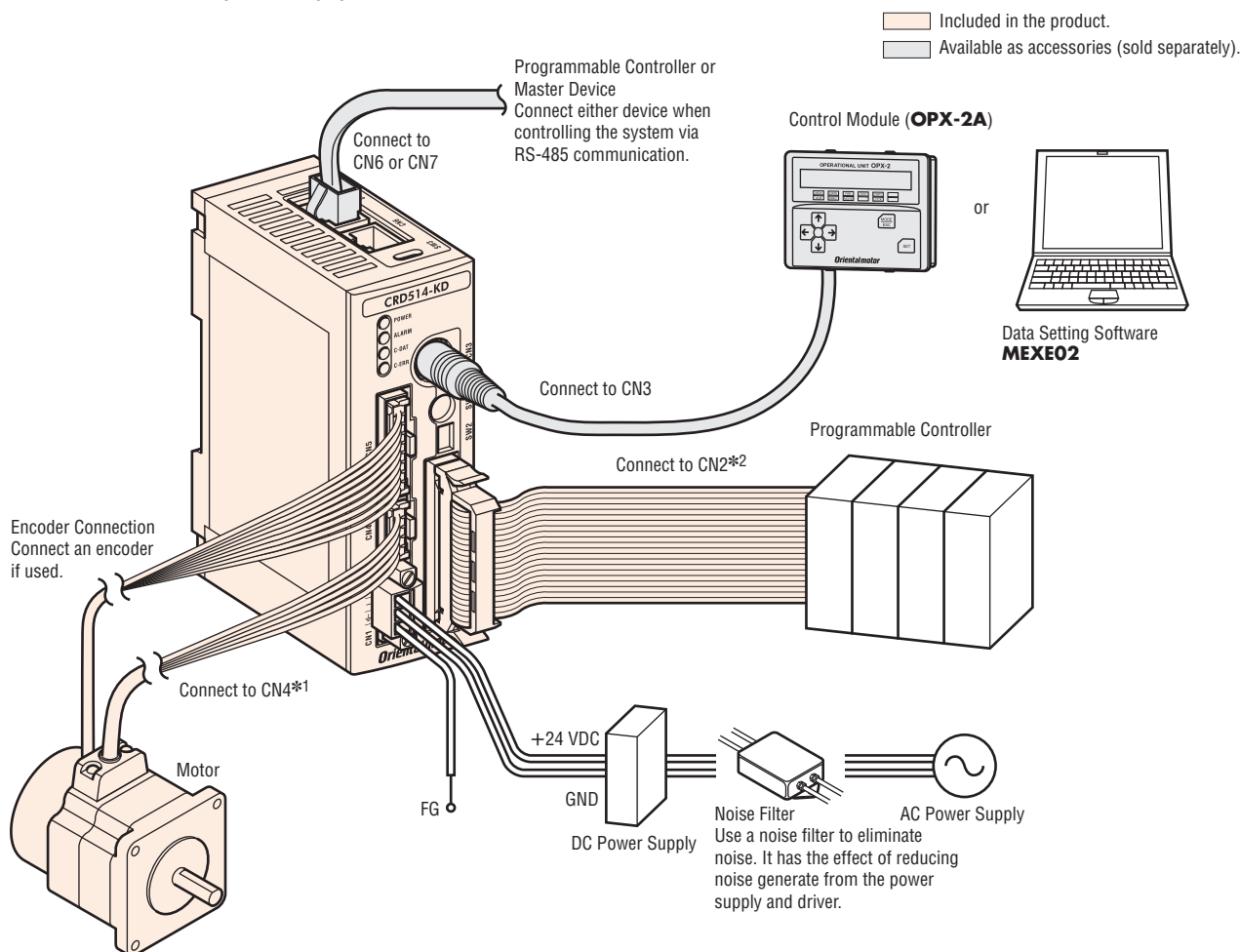

*1 If you are purchasing a package or only a driver, connection cable of 0.6 m will be supplied.

*2 If you are purchasing a package or only a driver, connection cable of 1 m will be supplied.

◇ Power Supply Connection

Use the CN1 connector (included) to connect the power supply cable (AWG22: 0.3 mm²) to the power supply connector (CN1) on the driver. Incorrect connection of DC power input will lead to driver damage.

Make sure that the polarity is correct before turning power on. Use a power supply that can supply sufficient input current.

When power supply capacity is insufficient, a decrease in motor output can cause the following malfunctions:

- Motor does not operate properly at high-speed
- Slow motor startup and stopping

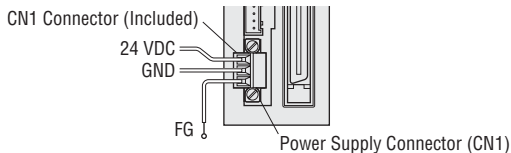

◇ Motor Connection

Connect the connection cable for CN4 (included) into the motor connector (CN4) on the driver. Next, connect the motor leads and the CN4 cable leads. The customer must provide a suitable terminal block, connectors and other items needed to interconnect the leads.

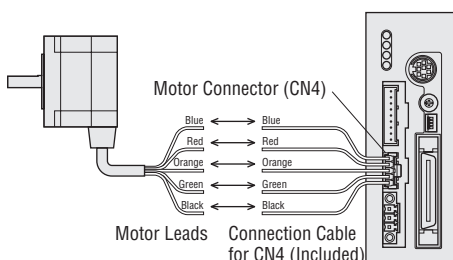

◇ Encoder Connection

Use the CN5 connector (Included) to connect to the encoder connector (CN5) on the driver.

● Example of Standard Type with Encoder

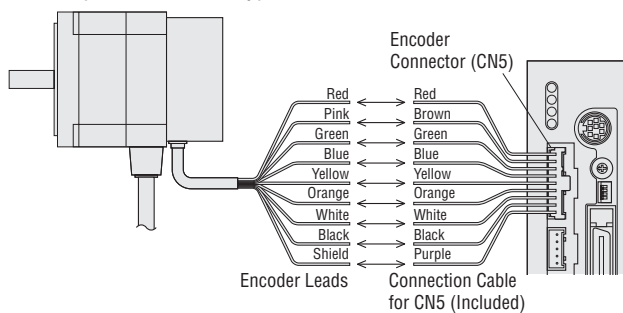

◇ Electromagnetic Brake Connection

Please provide a 24 VDC power supply.

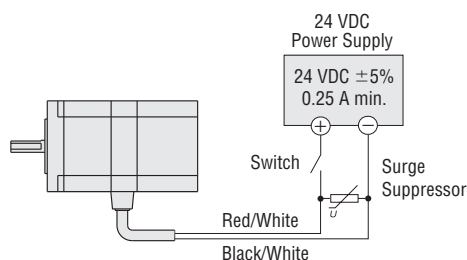

◇ Connecting to a Host Controller

● Connecting to a Current Source Output Circuit

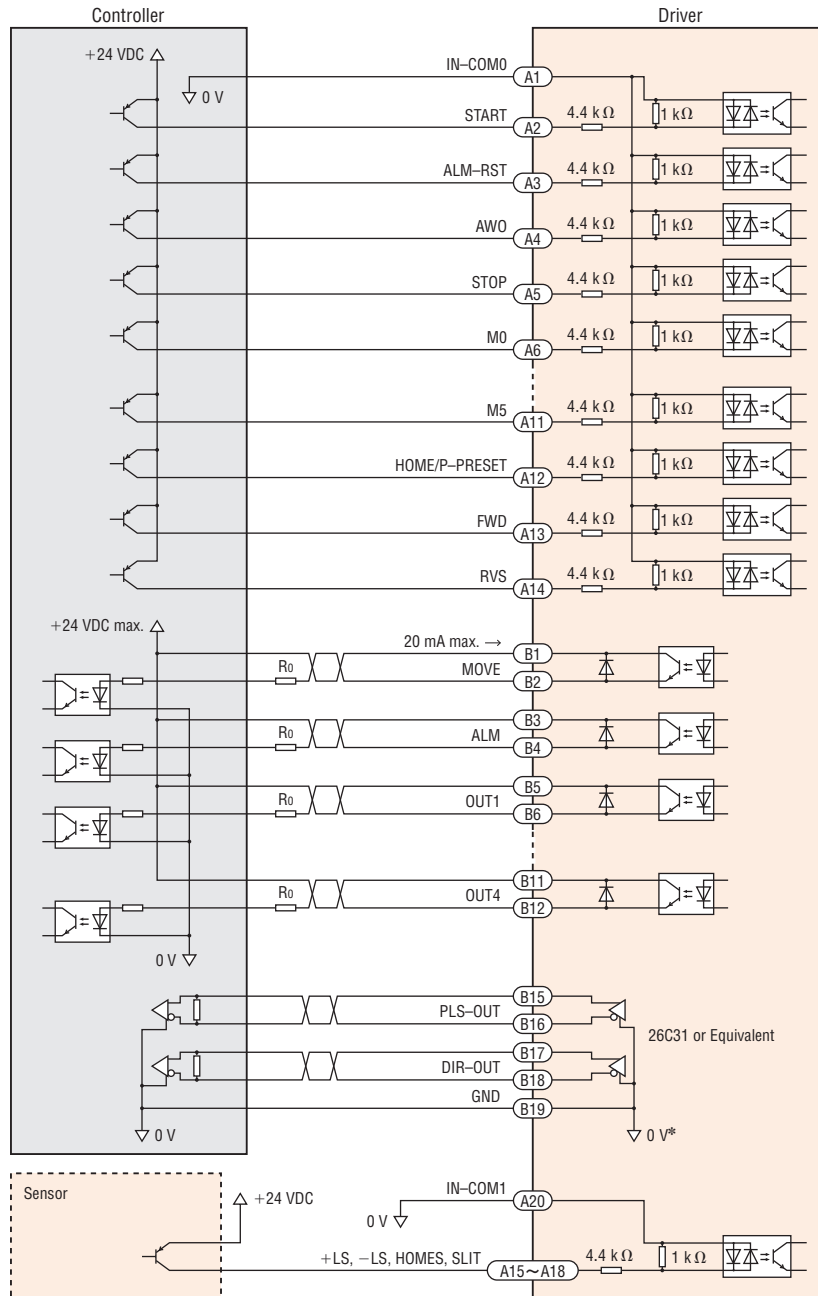

*The GND line is used in common with CN1 (not insulated)

Note

- Use the included connection cable as the I/O signal cable and keep it as short as possible.
- Use 24 VDC for the input signal. The internal components may be damaged if the specifications are exceeded.
- Use 24 VDC or less for the output signal, and 20 mA or less for the current. The internal components may be damaged if the specifications are exceeded. Check the specifications of the connected device, and if the current exceeds 20 mA, connect an external resistor R_0 .
- Connect a terminal resistor of 100 Ω or more between the input of the line receiver terminals.
- Signal lines should be kept at least 100 mm away from power lines (power supply lines and motor lines). Do not run the signal lines in the same duct or bundle them together.
- If noise generated by the motor cables or power supply cables causes a problem, try shielding the cables or using ferrite cores.

• Connecting to a Current Sink Output Circuit

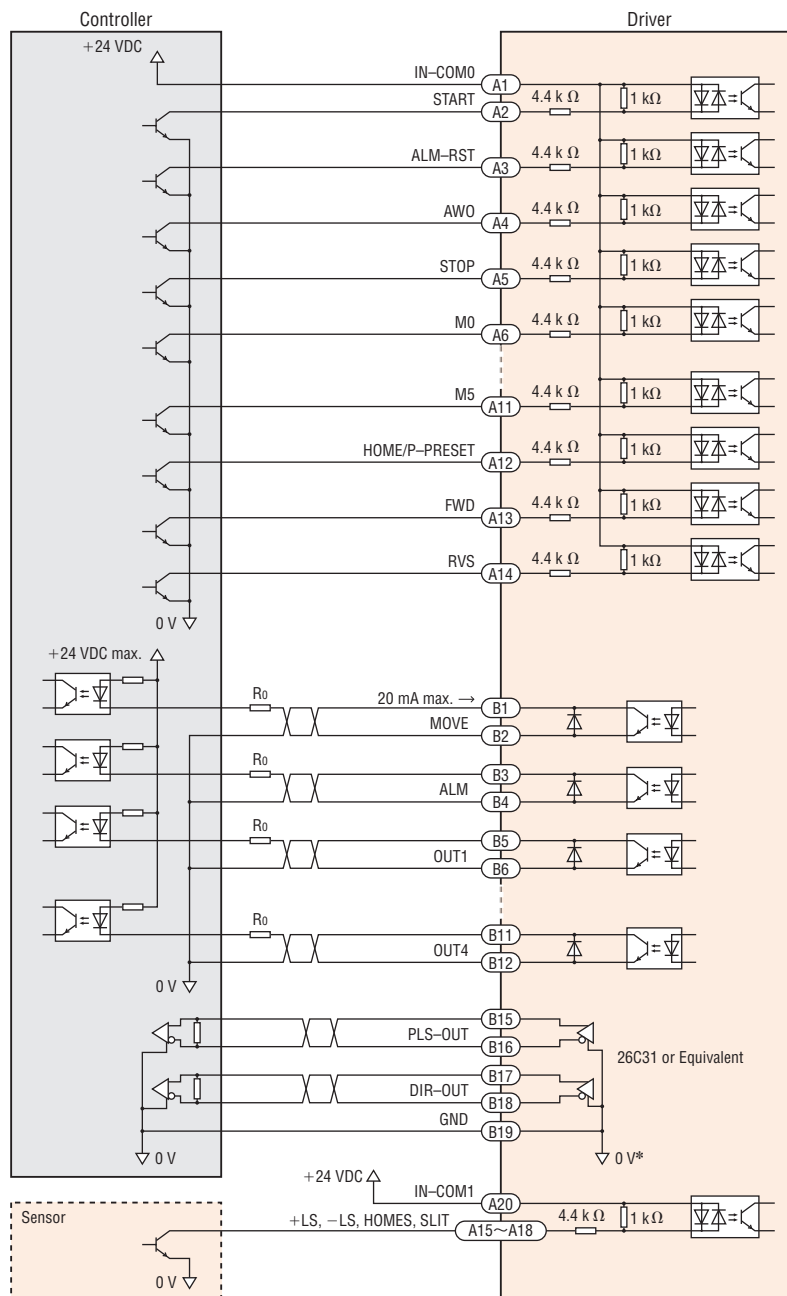

*The GND line is used in common with CN1 (not insulated)

Note

- Use the included connection cable as the I/O signal cable and keep it as short as possible.
- Use 24 VDC for the input signal. The internal components may be damaged if the specifications are exceeded.
- Use 24 VDC or less for the output signal, and 20 mA or less for the current. The internal components may be damaged if the specifications are exceeded. Check the specifications of the connected device, and if the current exceeds 20 mA, connect an external resistor R_0 .
- Connect a terminal resistor of 100 Ω or more between the input of the line receiver terminals.
- Signal lines should be kept at least 100 mm away from power lines (power supply lines and motor lines). Do not run the signal lines in the same duct or bundle them together.
- If noise generated by the motor cables or power supply cables causes a problem, try shielding the cables or using ferrite cores.

Connection and Operation (Pulse Input Package)

Names and Functions of Driver Parts

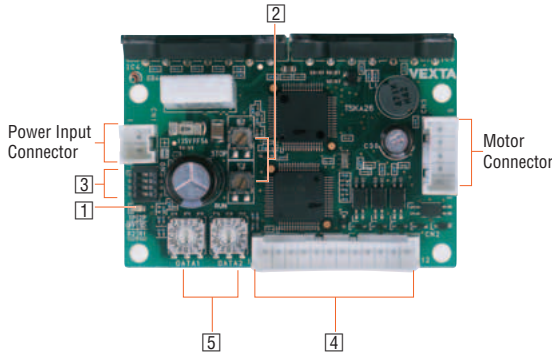

1 Power Input Display

Color	Function	When Activated
Green	Power supply indication	Lights when power is on.

2 Current Adjustment Potentiometers

Indication	Potentiometer Name	Function
RUN	Motor run current potentiometer	For adjusting the motor running current.
STOP	Motor stop current potentiometer	For adjusting the motor current at standstill.

3 Function Select Switches

Indication	Switch Name	Function
1P/2P	Pulse input mode switch	Switches between 1-pulse input and 2-pulse input.
OFF/SD	Smooth drive function switch	Enables or disables the smooth drive function.
R2/R1	Resolution select switch	Switches the basic step angle between R1 and R2.

4 Input/Output Signals

Indication	Input/Output	Pin No.	Signal Name	Function
CN2	Input	1	Pulse signal (CW pulse signal)	Operation command pulse signal (The motor will rotate in the CW direction when in 2-pulse input mode.)
		2		
		3	Rotation direction signal (CCW pulse signal)	Rotation direction signal Photocoupler ON: CW, Photocoupler OFF: CCW (The motor will rotate in the CCW direction when in 2-pulse input mode.)
		4		
		5	All windings off signal	Cuts the output current to the motor and allows the motor shafts can be rotated manually.
		6		
		7	Step angle select signal	Switches to step angle set in DATA1 and DATA2.
		8		
		9	Automatic current cutback release signal	This signal is used to disable the automatic current cutback function.
		10		
Output		11	Excitation timing signal	Outputs signals when the excitation sequence is at STEP "0".
		12		

5 Step Angle Setting Switches

Indication	Switch Name	Function
DATA1	Step angle setting switch	Each switch can be set to the desired resolution from the 16 resolution levels.
DATA2		

R1				R2			
DATA1 DATA2	Microsteps/ Step 1	Resolution 1	Step Angle 1	DATA1 DATA2	Microsteps/ Step 2	Resolution 2	Step Angle 2
0	1	500	0.72°	0	×2.5	200	1.8°
1	2	1000	0.36°	1	×1.25	400	0.9°
2	2.5	1250	0.288°	2	1.6	800	0.45°
3	4	2000	0.18°	3	2	1000	0.36°
4	5	2500	0.144°	4	3.2	1600	0.225°
5	8	4000	0.09°	5	4	2000	0.18°
6	10	5000	0.072°	6	6.4	3200	0.1125°
7	20	10000	0.036°	7	10	5000	0.072°
8	25	12500	0.0288°	8	12.8	6400	0.05625°
9	40	20000	0.018°	9	20	10000	0.036°
A	50	25000	0.0144°	A	25.6	12800	0.028125°
B	80	40000	0.009°	B	40	20000	0.018°
C	100	50000	0.0072°	C	50	25000	0.0144°
D	125	62500	0.00576°	D	51.2	25600	0.0140625°
E	200	100000	0.0036°	E	100	50000	0.0072°
F	250	125000	0.00288°	F	102.4	51200	0.00703125°

Note

- The step angle is calculated by dividing the basic step angle by the number of microstep. The above figures are based on a basic step angle of 0.72°.
- With the 0.36° high-torque type, the basic step angle and resolution are 0.36° and 1000 (microsteps/step 1), respectively.
- If you are using a geared type, the step angle divided by the gear ratio becomes the actual step angle.
- The number of microstep that can be switched by the "Step Angle Select" signal are limited to those selected in step angles 1 and 2.
- Do not change the "Step Angle Select" signal input or step angle setting switch while the motor is operating. It may cause the motor to misstep and stop.

● Connection Diagram

◇ Connecting to a Host Controller

● Connecting to a Current Source Output Circuit

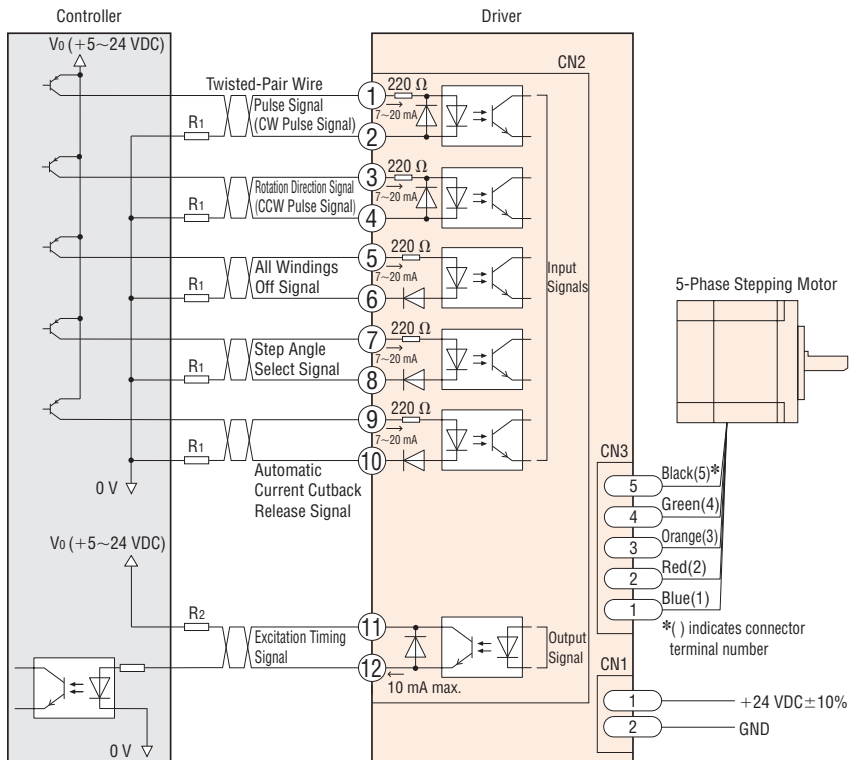

● Connecting to a Current Sink Output Circuit

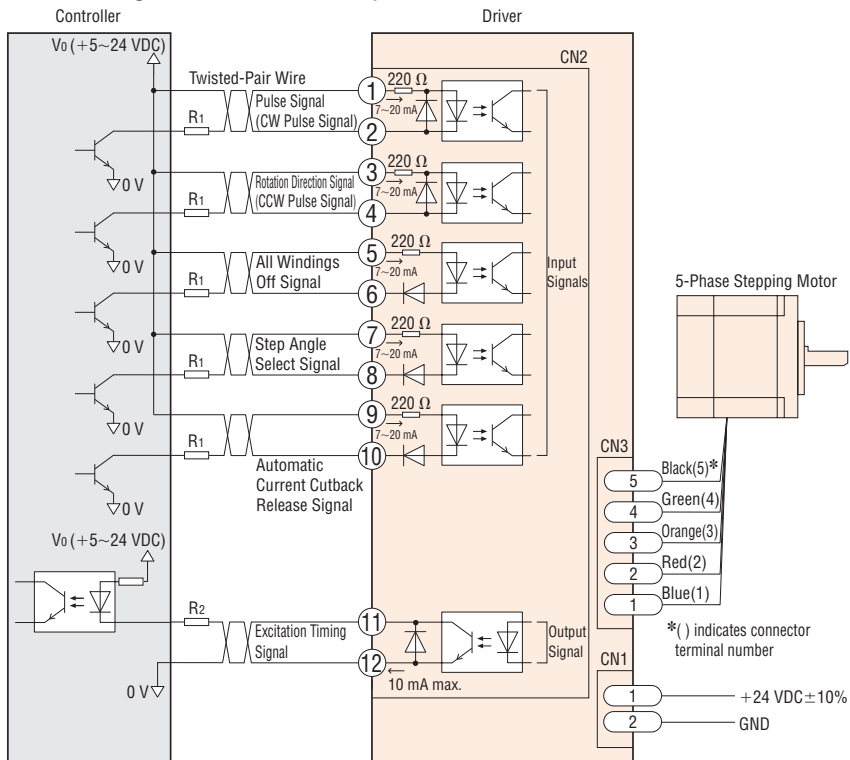

Notes on Wiring

◇ I/O Signal Connection

- Input Signal
Direct connection is possible when 5 VDC is applied. If a voltage exceeding 5 VDC is applied, connect an external resistor R_1 so that the current becomes 7 to 20 mA.
Example: When V_0 is 24 VDC, R_1 : 1.5 to 2.2 k Ω , 0.5 W min.
- Output Signal
Check the specifications of the connected device and if the current exceeds 10 mA, connect an external resistor R_2 .
- Use AWG24 to 22 (0.2~0.3 mm²) twisted-pair wires.
- Since the maximum transmissible frequency drops as the pulse line becomes longer, keep the wiring length as short as possible (within 2 m).
Technical reference → Page G-46
- Provide a distance of 100 mm min. between the I/O signal lines and power lines (power supply lines, motor lines, etc.).

◇ Power Supply Connection

- Use AWG22 (0.3 mm²) wires.
- Incorrect polarities of the DC power-supply input will lead to driver damage.
Make sure that the polarity is correct before turning power on.

◇ Extension of Motor Cable

- Use min. AWG22 (0.3 mm²) wires.

◇ General

- A separate hand crimp tool is required to crimp the included connector and lead wire. The accessory connection cable set (sold separately) comes with all lead wires already crimped.
- If noise generated by the motor cable or power supply cable causes a problem with the specific wiring or layout, try shielding the cables or using ferrite cores.

Motor and Driver Combinations

Product names for motor and driver combinations are shown below.

Built-In Controller Packages

Type	Product Name	Motor Product Name	Driver Product Name
High-Resolution Type	CRK523PM □ KD CRK524PM □ KD CRK525PM □ KD	PK523PM□* PK524PM□* PK525PM□*	CRD503-KD
	CRK523HPM □ KD CRK524HPM □ KD CRK525HPM □ KD	PK523HPM□* PK524HPM□* PK525HPM□*	CRD507H-KD
	CRK544PM □ KD CRK546PM □ KD	PK544PM□* PK546PM□*	CRD507-KD
	CRK564PM □ KD CRK566PM □ KD CRK569PM □ KD	PK564PM□* PK566PM□* PK569PM□*	CRD514-KD
High-Torque Type	CRK513P □ KD CRK523P □ KD CRK525P □ KD	PK513P□* PK523P□* PK525P□*	CRD503-KD
	CRK523HP □ KD CRK525HP □ KD	PK523HP□* PK525HP□*	CRD507H-KD
	CRK544P □ KD CRK546P □ KD	PK544P□* PK546P□*	CRD507-KD
	CRK513PRKD CRK523PRKD CRK525PRKD	PK513PA-R23L* PK523PA-R23L* PK525PA-R23L*	CRD503-KD
High-Torque Type with Encoder	CRK523HPRKD CRK525HPRKD	PK523HPA-R23L* PK525HPA-R23L*	CRD507H-KD
	CRK544PRKD CRK546PRKD	PK544PA-R23L* PK546PA-R23L*	CRD507-KD
Standard Type	CRK543 □ KD CRK544 □ KD CRK545 □ KD	PK543□W PK544□W PK545□W	CRD507-KD
	CRK564 □ KD CRK566 □ KD CRK569 □ KD	PK564□W PK566□W PK569□W	CRD514-KD
	CRK543AMKD CRK544AMKD CRK545AMKD	PK543AWM PK544AWM PK545AWM	CRD507-KD
Standard Type with Electromagnetic Brake	CRK564AMKD CRK566AMKD CRK569AMKD	PK564AWM PK566AWM PK569AWM	CRD514-KD
	CRK543RKD CRK544RKD CRK545RKD	PK543AW-R23L PK544AW-R23L PK545AW-R23L	CRD507-KD
	CRK564RKD CRK566RKD CRK569RKD	PK564AW-R23L PK566AW-R23L PK569AW-R23L	CRD514-KD

Type	Product Name	Motor Product Name	Driver Product Name
TH Geared Type	CRK523P □ KD-T7.2 CRK523P □ KD-T10 CRK523P □ KD-T20 CRK523P □ KD-T30	PK523P□-T7.2* PK523P□-T10* PK523P□-T20* PK523P□-T30*	CRD503-KD
	CRK543 □ KD-T3.6 CRK543 □ KD-T7.2 CRK543 □ KD-T10 CRK543 □ KD-T20 CRK543 □ KD-T30	PK543□W-T3.6 PK543□W-T7.2 PK543□W-T10 PK543□W-T20 PK543□W-T30	CRD507-KD
	CRK564 □ KD-T3.6 CRK564 □ KD-T7.2 CRK564 □ KD-T10 CRK564 □ KD-T20 CRK564 □ KD-T30	PK564□W-T3.6 PK564□W-T7.2 PK564□W-T10 PK564□W-T20 PK564□W-T30	CRD514-KD
	CRK523P □ KD-PS5 CRK523P □ KD-PS7 CRK523P □ KD-PS10	PK523P□-PS5* PK523P□-PS7* PK523P□-PS10*	CRD503-KD
PS Geared Type	CRK545 □ KD-PS5 CRK545 □ KD-PS7 CRK545 □ KD-PS10 CRK543 □ KD-PS25 CRK543 □ KD-PS36 CRK543 □ KD-PS50	PK545□W-PS5 PK545□W-PS7 PK545□W-PS10 PK543□W-PS25 PK543□W-PS36 PK543□W-PS50	CRD507-KD
	CRK566 □ KD-PS5 CRK566 □ KD-PS7 CRK566 □ KD-PS10 CRK564 □ KD-PS25 CRK564 □ KD-PS36 CRK564 □ KD-PS50	PK566□W-PS5 PK566□W-PS7 PK566□W-PS10 PK564□W-PS25 PK564□W-PS36 PK564□W-PS50	CRD514-KD
	CRK523P □ KD-N5 CRK523P □ KD-N7.2 CRK523P □ KD-N10	PK523P□-N5* PK523P□-N7.2* PK523P□-N10*	CRD503-KD
	CRK544 □ KD-N5 CRK544 □ KD-N7.2 CRK544 □ KD-N10	PK544□W-N5 PK544□W-N7.2 PK544□W-N10	CRD507-KD
PN Geared Type	CRK566 □ KD-N5 CRK566 □ KD-N7.2 CRK566 □ KD-N10 CRK564 □ KD-N25 CRK564 □ KD-N36 CRK564 □ KD-N50	PK566□W-N5 PK566□W-N7.2 PK566□W-N10 PK564□W-N25 PK564□W-N36 PK564□W-N50	CRD514-KD
	CRK513P □ KD-H50 CRK513P □ KD-H100	PK513P□-H50S* PK513P□-H100S*	CRD503-KD
	CRK523P □ KD-H50 CRK523P □ KD-H100	PK523HP□-H50S* PK523HP□-H100S*	CRD507H-KD
	CRK543 □ KD-H50 CRK543 □ KD-H100	PK543□W-H50S PK543□W-H100S	CRD507-KD
Harmonic Geared Type	CRK564 □ KD-H50 CRK564 □ KD-H100	PK564□W-H50S PK564□W-H100S	CRD514-KD

● Either **A** or **B** indicating the motor shaft type is entered where the box □ is located within the product name.

* If you are purchasing only a motor for maintenance purposes, etc., connection cable and connector will not be supplied. Please provide separately. Connection cable and motor connector set are also available as accessories.

Connection cables → Page A-352

Motor connector sets → Page A-354

● Pulse Input Packages

Type	Product Name	Motor Product Name	Driver Product Name
High-Resolution Type	CRK523PM □P CRK524PM □P CRK525PM □P	PK523PM□* PK524PM□* PK525PM□*	CRD5103P
	CRK523HPM □P CRK524HPM □P CRK525HPM □P	PK523HPM□* PK524HPM□* PK525HPM□*	CRD5107HP
	CRK544PM □P CRK546PM □P	PK544PM□* PK546PM□*	CRD5107P
	CRK564PM □P CRK566PM □P CRK569PM □P	PK564PM□* PK566PM□* PK569PM□*	CRD5114P
High-Torque Type	CRK513P □P	PK513P□*	CRD5103P
	CRK523P □P CRK525P □P	PK523P□* PK525P□*	
	CRK523HP □P CRK525HP □P	PK523HP□* PK525HP□*	CRD5107HP
	CRK544P □P CRK546P □P	PK544P□* PK546P□*	
Standard Type	CRK543 □P CRK544 □P CRK545 □P	PK543N□W PK544N□W PK545N□W	CRD5107P
	CRK564 □P CRK566 □P CRK569 □P	PK564N□W PK566N□W PK569N□W	CRD5114P
	CRK523P □P-T7.2 CRK523P □P-T10 CRK523P □P-T20 CRK523P □P-T30	PK523P□-T7.2* PK523P□-T10* PK523P□-T20* PK523P□-T30*	CRD5103P
TH Geared Type	CRK543 □P-T3.6 CRK543 □P-T7.2 CRK543 □P-T10 CRK543 □P-T20 CRK543 □P-T30	PK543□W-T3.6 PK543□W-T7.2 PK543□W-T10 PK543□W-T20 PK543□W-T30	CRD5107P
	CRK564 □P-T3.6 CRK564 □P-T7.2 CRK564 □P-T10 CRK564 □P-T20 CRK564 □P-T30	PK564□W-T3.6 PK564□W-T7.2 PK564□W-T10 PK564□W-T20 PK564□W-T30	CRD5114P

● Either **A** or **B** indicating the motor shaft type is entered where the box □ is located within the product name.

* If you are purchasing only a motor for maintenance purposes, etc., connection cable and connector will not be supplied. Please provide separately. Connection cable and motor connector set are also available as accessories.

Connection cables → Page A-352

Motor connector sets → Page A-354

Type	Product Name	Motor Product Name	Driver Product Name
PS Geared Type	CRK523P □P-PS5 CRK523P □P-PS7 CRK523P □P-PS10	PK523P□-PS5* PK523P□-PS7* PK523P□-PS10*	CRD5103P
	CRK545 □P-PS5 CRK545 □P-PS7 CRK545 □P-PS10 CRK543 □P-PS25 CRK543 □P-PS36 CRK543 □P-PS50	PK545□W-PS5 PK545□W-PS7 PK545□W-PS10 PK543□W-PS25 PK543□W-PS36 PK543□W-PS50	CRD5107P
	CRK566 □P-PS5 CRK566 □P-PS7 CRK566 □P-PS10 CRK564 □P-PS25 CRK564 □P-PS36 CRK564 □P-PS50	PK566□W-PS5 PK566□W-PS7 PK566□W-PS10 PK564□W-PS25 PK564□W-PS36 PK564□W-PS50	CRD5114P
	CRK523P □P-N5 CRK523P □P-N7.2 CRK523P □P-N10	PK523P□-N5* PK523P□-N7.2* PK523P□-N10*	CRD5103P
PN Geared Type	CRK544 □P-N5 CRK544 □P-N7.2 CRK544 □P-N10	PK544□W-N5 PK544□W-N7.2 PK544□W-N10	CRD5107P
	CRK566 □P-N5 CRK566 □P-N7.2 CRK566 □P-N10 CRK564 □P-N25 CRK564 □P-N36 CRK564 □P-N50	PK566□W-N5 PK566□W-N7.2 PK566□W-N10 PK564□W-N25 PK564□W-N36 PK564□W-N50	CRD5114P
	CRK513P □P-H50 CRK513P □P-H100	PK513P□-H50S* PK513P□-H100S*	CRD5103P
	CRK523P □P-H50 CRK523P □P-H100 CRK543 □P-H50 CRK543 □P-H100 CRK564 □P-H50 CRK564 □P-H100	PK523HP□-H50S* PK523HP□-H100S* PK543□W-H50S PK543□W-H100S PK564□W-H50S PK564□W-H100S	CRD5107HP CRD5107P CRD5114P

Introduction

0.36°/Geared
AR
AC Input Motor & Driver

0.72°/Geared
RK
AC Input Motor & Driver

0.36°/Geared
AR
DC Input Motor & Driver

0.36°/0.72°/
Geared
CRK
DC Input Motor & Driver

1.8°/Geared
RK
DC Input Motor & Driver

0.9°/1.8°/Geared
CMK
DC Input Motor & Driver

0.72°
PK
Motor Only

1.8°/Geared
High-Torque
PKP
Motor Only

0.9°/1.8°/Geared
PK
Motor Only

Controllers
SG80301Y

Accessories